

2360 Boswell Road
Chula Vista, CA 91914
Phone 619.216.1444
Fax 619.216.1474
E-Mail tech@explorerprocomp.com



PRO COMP SUSPENSION

Suspension Systems that Work!

**Part #
52820B/52820BMX
2008-2009 Ford Super
Duty 4WD F250-350
2" Leveling Kit**

This document contains very important information that includes warranty information and instructions for resolving problems you may encounter. Please keep it in the vehicle as a permanent record.

Box 1 of 2-PN52820B/52820BMX-1

Part #	Description	Qty.	Illus.	Page
90-3882	2" TRACK BAR DROP BRACKET	1	1,3,4	5,7,8
90-4117	2" ALUMINUM COIL SPACER	2	2	6
90-6373	HARDWARE PACK: Clamps and Spacers	1	-	-
171006ERL	AN6 ADEL CLAMPS	4	2	6
90-2501	BRAKE LINE BRACKET SPACER	2	2	6
90-3168	COIL SPACER SIDE PLATE 6MM	2	2	6
90-3158	COIL SPACER SIDE PLATE 8MM	2	2	6
90-6368	HARDWARE PACK: Coil Spacer	1	-	-
71-141002001000	14MM-2.0 X 100MM 10.9 BOLT	2	2	6
73-01410930	14MM FLAT WASHER	2	2	6
70-0311001802	5/16-18 X 1" ALLEN HEAD BOLT	2	2	6
70-0311001800	5/16" X 1" GR. 8 HEX HEAD BOLT	6	2	6
73-0310530	5/16" SAE GR. 8 FLAT WASHER	8	2	6
71-060151008800	6MM-1.0 X 16MM BOLT 8.8	4	2	6
73-00608830	6MM FLAT WASHER	4	2	6
71-080201258800	8MM-1.25 X 20MM BOLT 8.8	4	2	6
73-00808830	8MM FLAT WASHER	4	2	6
95-150F	1 1/2" ALUMINUM LIFT BLOCK	2	5	10
90-6369	HARDWARE PACK: Track Bar Bracket	1	-	-
70-0563001800	9/16" X 3" HEX BOLT GR. 8	3	1	5
72-056100816	9/16" STOVER NUT	3	1	5
73-05600830	9/16" SAE GR. 8 FLAT WASHER	6	1	5
13-90190	5/8" U-BOLT	4	5	10
20-65471	HARDWARE PACK: Hi Nuts	1	5	10

Box 2 of 2-PN 52820B-2

922553	FRONT SHOCKS	2	-	-
932008	REAR SHOCKS	2	-	-

(OR) Box 2 of 2-PN 52820BMX-2

MX6123	MX6 FRONT SHOCKS	2	-	-
MX6018	MX6 REAR SHOCKS	2	-	-

Introduction:

- ◆ **This installation requires a professional mechanic!**
- ◆ We recommend that you have access to a factory service manual for your vehicle to assist in the disassembly and reassembly of your vehicle. It contains a wealth of detailed information.
- ◆ Prior to installation, carefully inspect the vehicle's steering and driveline systems paying close attention to the tie rod ends, ball joints, wheel bearing preload, pitman and idler arm. Additionally, check steering-to-frame and suspension-to-frame attaching points for stress cracks. The overall vehicle must be in excellent working condition. Repair or replace all worn or damaged parts!
- ◆ Read the instructions carefully and study the illustrations before attempting installation! You may save yourself a lot of extra work.
- ◆ Check the parts and hardware against the parts list to assure that your kit is complete. Separating parts according to the areas where they will be used and placing the hardware with the brackets before you begin will save installation time.
- ◆ Check the special equipment list and ensure the availability of these tools.
- ◆ Secure and properly block vehicle prior to beginning installation.
- ◆ ALWAYS wear safety glasses when using power tools or working under the vehicle!
- ◆ Use caution when cutting is required under the vehicle. The factory undercoating is flammable. Take appropriate precautions. Have a fire extinguisher close at hand.
- ◆ Foot pound torque readings are listed on the Torque Specifications chart at the end of the instructions. These are to be used unless specifically directed otherwise. Apply thread lock retaining compound where specified.
- ◆ **Please note that while every effort is made to ensure that the installation of your Pro Comp lift kit is a positive experience, variations in construction and assembly in the vehicle manufacturing process will virtually ensure that some parts may seem difficult to install. Additionally, the current trend in manufacturing of vehicles results in a frame that is highly flexible and may shift slightly on disassembly prior to installation. The use of pry bars and tapered punches for alignment is considered normal and usually does not indicate a faulty product. However, if you are uncertain about some aspect of the installation process, please feel free to call our tech support department at the number listed on the cover page. We do not recommend that you modify the Pro Comp parts in any way as this will void any warranty expressed or implied by the Pro Comp Suspension company.**

Please Note:

- ⇒ Front suspension and head light realignment is necessary!
- ⇒ Speedometer and ABS recalibration will be necessary if larger tires (10% more than stock diameter) are installed.
- ⇒ **IT IS ADVISABLE THAT YOU HAVE HELP AVAILABLE WHEN INSTALLING THIS KIT. SOME COMPONENTS ARE HEAVY AND AWKWARD. AN ADDITIONAL SET OF HANDS IS GOOD INSURANCE AGAINST INJURY!**

Important!

Due to differences in manufacturing, dimensions and inflated measurements, tire and wheel combinations should be test fit prior to installation. Tire and wheel choice is crucial in assuring proper fit, performance, and the safety of your Pro Comp equipped vehicle. For this application, we recommend a wheel not to exceed 8" in width with a maximum backspacing of 5 3/4" must be used. Additionally, a quality tire of radial design, not exceeding 33" tall X 12.5" wide is also recommended. Violation of these recommendations will not be endorsed as acceptable by Pro Comp Suspension and will void any and all warranties either written or implied.

Before You Begin:

- ⇒ Read the instructions and study the illustrations before attempting the installation.
- ⇒ Separating the parts according to the areas where they will be used and placing the hardware with the brackets before you begin will save installation time.
- ⇒ Check the parts and hardware against the parts list to assure that your kit is complete.
- ⇒ ALWAYS wear safety glasses when using power tools or working beneath your vehicle.
- ⇒ Always use NEW cotter pins on re-assembly! (These items are NOT supplied)

Optional Equipment Available from your Pro Comp Distributor!

LIGHTS

52480: CARRIER BEARING SHIM KIT

599: ALIGNMENT CAM KIT

219567: DUAL STEERING STABILIZER

72400: TRACTION BARS

72099: TRACTION BAR MOUNTING KIT

Also, check out our outstanding selection of Pro Comp tires to compliment your new installation!

Front Installation:

1. Position your vehicle on a smooth, flat, hard surface (i.e. concrete or asphalt) and block the rear tires. Set the emergency brake.
2. Measure and record the distance from the center of each wheel to the top of its fender opening. Record below.

LF: _____ RF: _____

LR: _____ RR: _____

3. Remove the track rod bolt from the driver side frame mount. Save this hardware for re-use.
4. Place the vehicle in neutral. Place your floor jack under the front axle and raise the vehicle. Place jack stands under the frame rails and lower the frame onto the stands. Remove the jack and place the vehicle back in gear, set the emergency brake and place blocks both in front and behind the rear wheels.
5. Undo the brake line brackets and ABS lines from the factory lower coil mounts.
6. Remove the factory plastic brake line clips from the ABS lines.
7. Remove the cast track bar mount from the driver side of the vehicle. Save the **OE** bolts and pal nuts they will be re-used.
8. Install track bar drop bracket (**90-3882**) using **(3) 9/16" X 3"** bolts, hardware and **(2) OE** bolts and pal nuts. Use thread locker on the bolts. See ILLUSTRATION 1. Torque bolts to 129 ft. lbs. Do not install track bar

at this time.

9. Disconnect the sway bar from the sway bar end links. Save hardware for reuse.
10. Raise axle enough to relieve tension on the shock hardware and remove the shocks from the vehicle.
11. Working on one side of the vehicle at a time, lower the front axle enough to remove the coil from the driver side front spring pocket. Save the isolators for re-use.
12. Remove the factory lower coil mount center bolt and re-

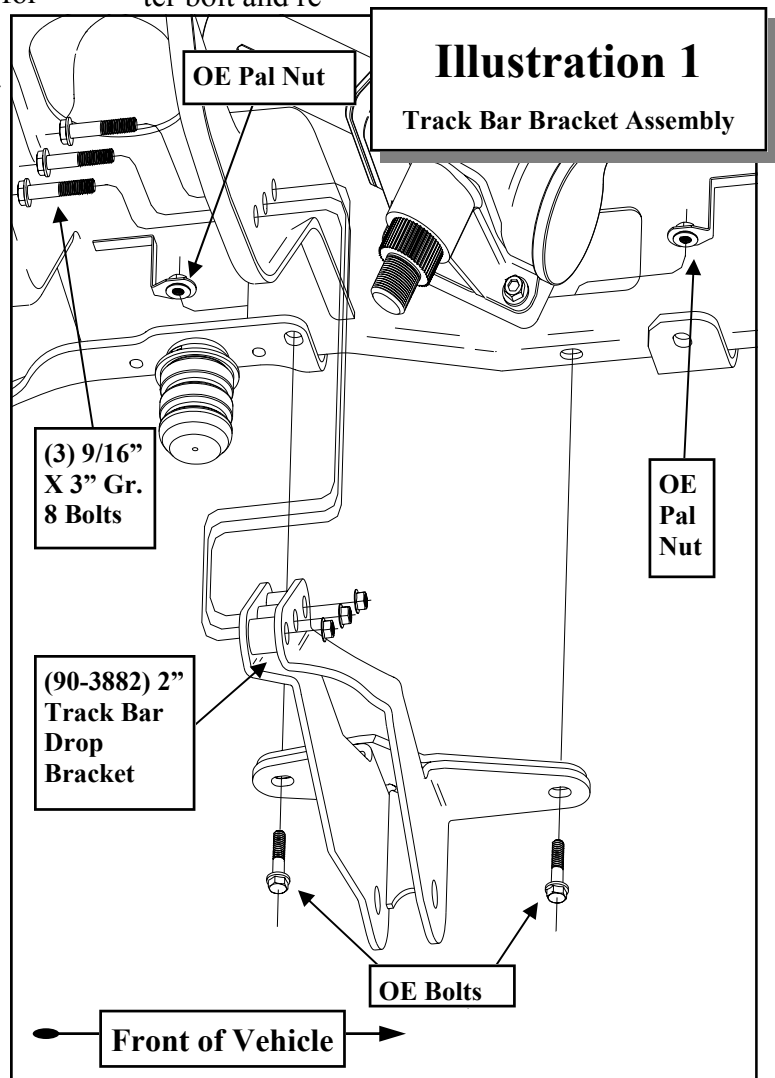
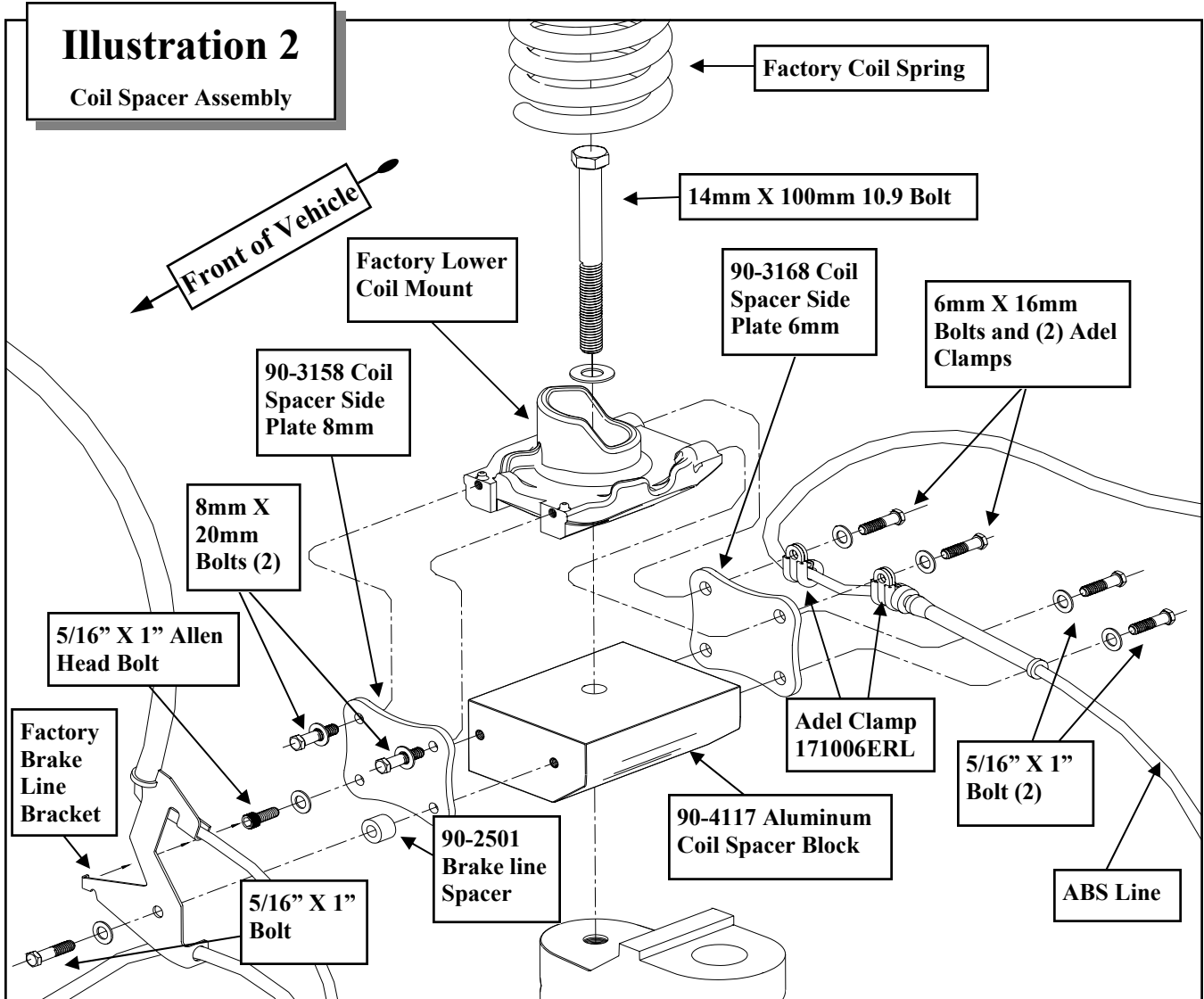
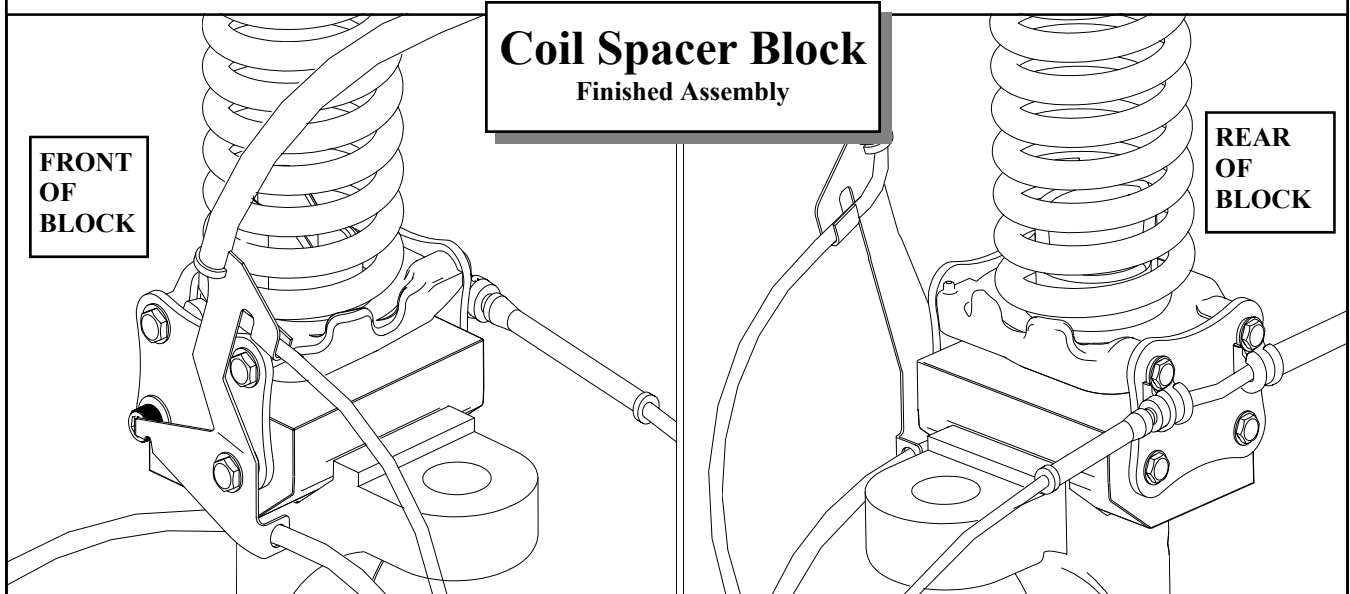

Illustration 2

Coil Spacer Assembly



Coil Spacer Block Finished Assembly



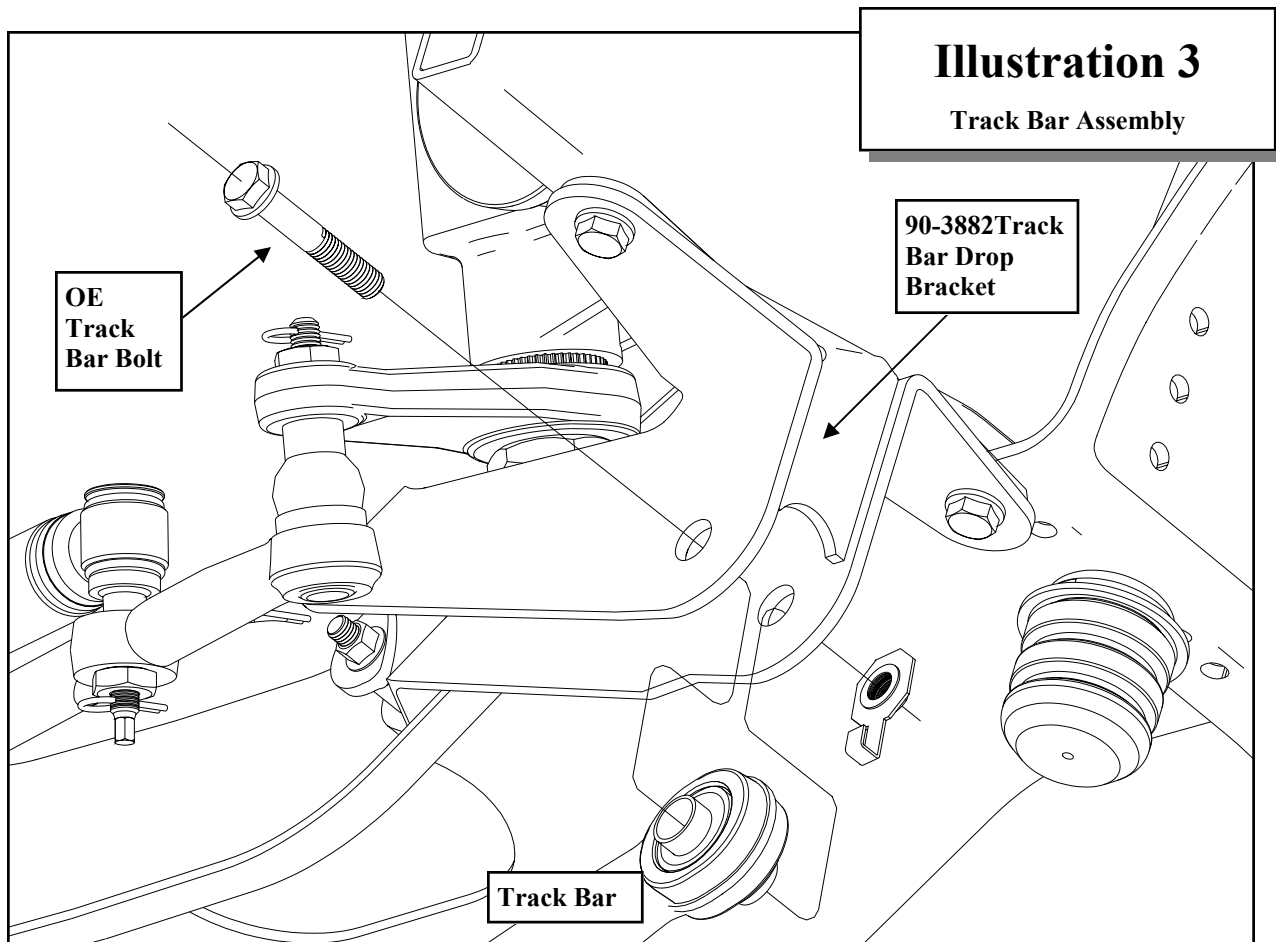

move the lower coil mount.

13. Insert the new 2" aluminum coil spacer (90-4117) with the factory lower coil mount on top and secure with the supplied 14mm X 100mm bolt. Do not tighten at this time. See ILLUSTRATION 2.
14. Install the 8mm coil spacer side plate (90-3158) to the front of the factory lower coil mount. Using the supplied 8mm X 20mm bolts in the 2 top holes. See ILLUSTRATION 2.
15. On the bottom front inside hole, insert the supplied 5/16" X 1" Allen head bolt and hardware.
16. On the bottom front outside hole, insert the 5/16" X 1" hex head bolt, hardware, brake line bracket spacer (90-2501) and the factory brake line bracket. See IL-

ILLUSTRATION 2.

NOTE: Make sure the tab on the brake line bracket fits into the Allen head of the previously installed inner Allen head bolt.

16. On the rear of the factory lower coil mount install the 6mm coil spacer side plate (90-3168) using the (2) supplied 6mm X 16mm bolts, hardware and supplied brake line clamps (171006ERL) in the top 2 holes. See ILLUSTRATION 2.
17. On the bottom rear holes secure using the supplied (2) 5/16" X 1" hex head bolts and hardware. See ILLUSTRATION 2.
18. Repeat on the remaining side of the vehicle.
19. Reinstall the factory coil springs into the

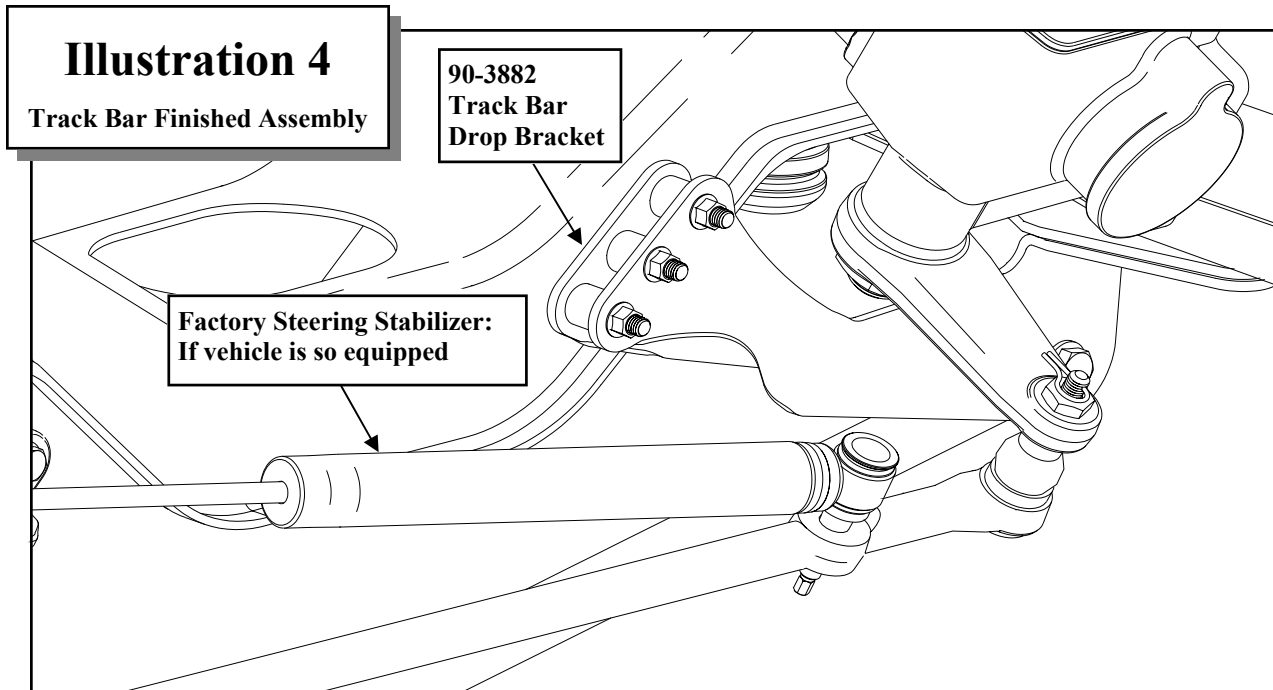

upper coil buckets using the factory isolators and onto the lower coil mounts.

20. Raise the axle using the floor jack.
21. Install the new shocks (**PN 922553 or MX6123**). Torque the upper mounting hardware to 46 ft. lbs. and the lower mounting hardware to 111 ft. lbs. Use thread locker on these bolts.
22. Reinstall the front wheels and torque to factory specifications.
23. Reattach the sway bar to the sway bar end links and fasten to factory specifications.
24. Using the **OE** hardware reinstall the track bar into the Pro Comp track bar bracket (**90-3882**) and torque to 406 ft. lbs. See ILLUSTRATION 3.
25. On both sides of the vehicle, check the routing of the brake lines and the ABS wire harnesses. There must be no pinching, rubbing, or stretching of either component. At full droop, cycle the steering from lock to lock while observing the reaction of these components. Reposition them if needed.

NOTES:

- ⇒ **On completion of the installation, have the suspension and headlights re-aligned.**
- ⇒ **After 100 miles recheck for proper torque on all newly installed hardware.**
- ⇒ **Recheck all hardware for tightness after off road use.**

Rear Installation:

1. Block the front tires and raise the rear of the vehicle. Support the frame with jack stands forward of the rear springs.
2. Remove the shocks on both sides of the vehicle. It may be necessary that you slightly raise the axle to unload the shocks for removal.

Please Note:

* **NOTE: FOR VEHICLES EQUIPPED WITH THE FACTORY 4" BLOCK SKIP TO STEP 11.**

* **NOTE: FOR VEHICLES EQUIPPED WITH THE FACTORY 2 1/4" BLOCK COMPLETE STEPS 3 THROUGH 13.**

3. Remove the rear wheels and tires.
4. On the driver side, unbolt the emergency brake line bracket from the upper spring plate.
5. Support the rear axle with a floor jack and loosen the **U-bolts** on the passenger side . Remove the **U-bolts** on the driver side.
6. Lower the rear axle and install the supplied lift block (**95-150F**) underneath the factory block if needed. Raise the axle to the spring and secure with the supplied **U-bolts (13-90190)** and **5/8"** hi nuts from pack (**20-65471**). Do not tighten these bolts at this time.
7. Bolt the emergency brake line bracket back on to the upper spring plate.
8. Repeat steps 4 through 7 on the other side of the vehicle.
9. Tighten the **U-bolts** to 120 ft. lbs.

10. Reinstall the wheels and tires.
11. Install your new Pro Comp shocks (**PN 932008 or MX6018**). Torque the upper mounting hardware to 46 ft. lbs. and the lower mounting hardware to 66 ft. lbs. Use thread locker on these bolts.
12. Lower the vehicle to the ground.
13. Re-check *all* hardware (both the front and the rear) for proper installation and torque!!
14. On both sides of the vehicle, check the routing of the brake lines and the ABS wire harnesses. There must be no pinching, rubbing, or stretching of either component. Reposition them if needed.

NOTES:

- ⇒ **On completion of the installation, have the suspension and headlights re-aligned.**
- ⇒ **After 100 miles recheck for proper torque on all newly installed hardware.**
- ⇒ **Recheck all hardware for tightness after off road use.**

Illustration 5

Rear Spring Assembly

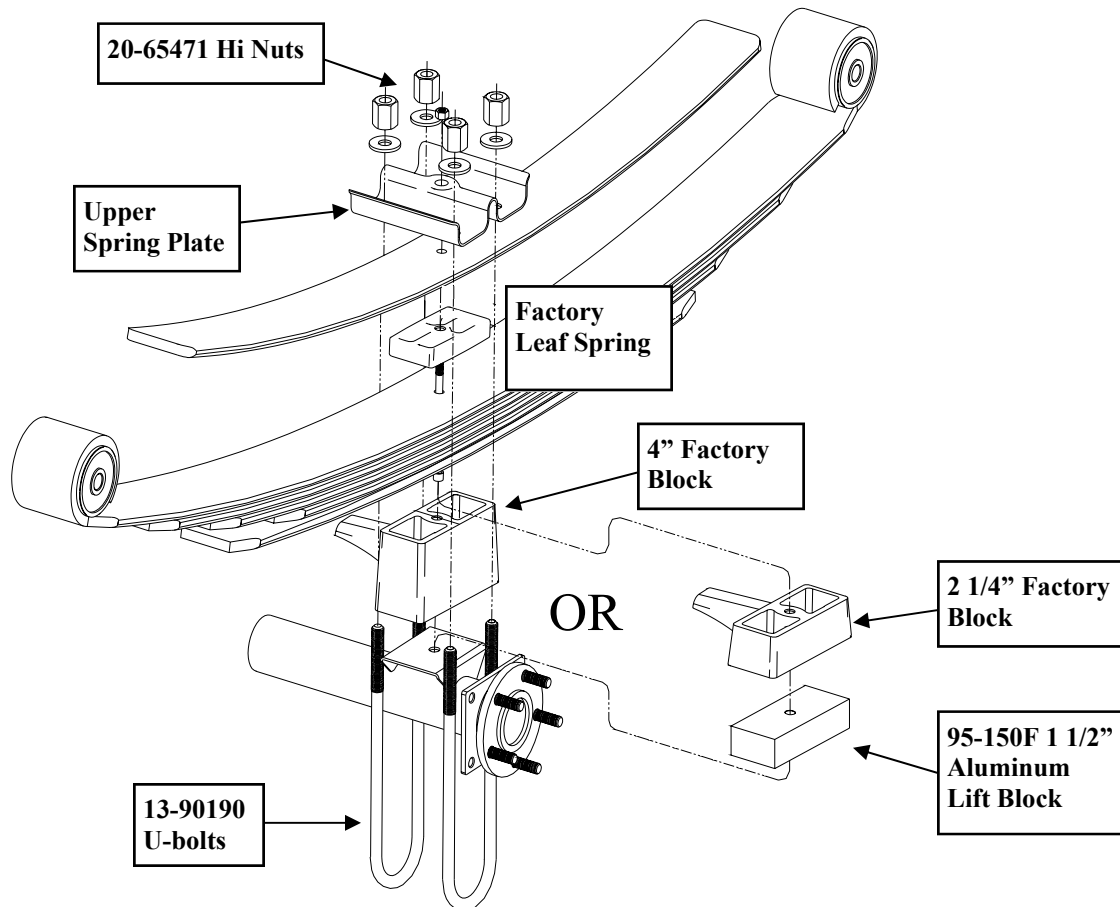

Pro Comp Recommended Rear Spacer Options

1. 4" Factory block **ONLY**
OR
2. 2 1/4" Factory block and 1 1/2" lift block, PN 95-150F

See Inset box after instruction 2.

Use this only as a guide for hardware without a called out torque specification in the instruction manual.

Bolt Torque and ID						
Decimal System			Metric System			
All Torques in Ft. Lbs. Maximums						
Bolt Size	Grade 5	Grade 8	Bolt Size	Class 9.8	Class 10.9	Class 12.9
5/16	15	20	M6	5	9	12
3/8	30	45	M8	18	23	27
7/16	45	60	M10	32	45	50
1/2	65	90	M12	55	75	90
9/16	95	130	M14	85	120	145
5/8	135	175	M16	130	165	210
3/4	185	280	M18	170	240	290

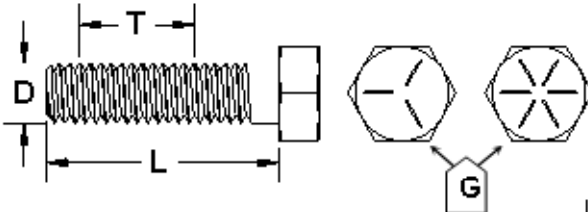
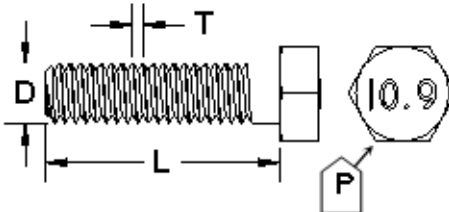
 <p>1/2-13x1.75 HHCS Grade 5 Grade 8 (No. of Marks + 2)</p> <p>D T L X</p> <p>G = Grade (Bolt Strength) D = Nominal Diameter (Inches) T = Thread Count (Threads per Inch) L = Length (Inches) X = Description (Hex Head Cap Screw)</p>	 <p>M12-1.25x50 HHCS</p> <p>D T L X</p> <p>P = Property Class (Bolt Strength) D = Nominal Diameter (Millimeters) T = Thread Pitch (Thread Width, mm) L = Length (Millimeters) X = Description (Hex Head Cap Screw)</p>
--	--

Notice to Owner operator, Dealer and Installer:

Vehicles that have been enhanced for off-road performance often have unique handling characteristics due to the higher center of gravity and larger tires. This vehicle may handle, react and stop differently than many passenger cars or unmodified vehicles, both on and off-road. You must drive your vehicle safely! Extreme care should always be taken to prevent vehicle rollover or loss of control, which can result in serious injury or even death. Always avoid sudden sharp turns or abrupt maneuvers and allow more time and distance for braking! Pro Comp reminds you to fasten your seat belts at all times and reduce speed! We will gladly answer any questions concerning the design, function, maintenance and correct use of our products.

Please make sure your Dealer/Installer explains and delivers all warning notices, warranty forms and instruction sheets included with Pro Comp product.

Application listings in this catalog have been carefully fit checked for each model and year denoted. However, Pro Comp reserves the right to update as necessary, without notice, and will not be held responsible for misprints, changes or variations made by vehicle manufacturers. Please call when in question regarding new model year, vehicles not listed by specific body or chassis styles or vehicles not originally distributed in the USA.

Please note that certain mechanical aspects of any suspension lift product may accelerate ordinary wear of original equipment components. Further, installation of certain Pro Comp products may void the vehicle's factory warranty as it pertains to certain covered parts; it is the consumer's responsibility to check with their local dealer for warranty coverage before installation of the lift.

Warranty and Return policy:

Pro Comp warrants its full line of products to be free from defects in workmanship and materials. Pro Comp's obligation under this warranty is limited to repair or replacement, at Pro Comp's option, of the defective product. Any and all costs of removal, installation, freight or incidental or consequential damages are expressly excluded from this warranty. Pro Comp is not responsible for damages and / or warranty of other vehicle parts related or non-related to the installation of Pro Comp product. A consumer who makes the decision to modify his vehicle with aftermarket components of any kind will assume all risk and responsibility for potential damages incurred as a result of their chosen modifications. Warranty coverage does not include consumer opinions regarding ride comfort, fitment and design. Warranty claims can be made directly with Pro Comp or at any factory authorized Pro Comp dealer.

IMPORTANT! To validate the warranty on this purchase please be sure to mail in the warranty card.

Claims not covered under warranty-

- Parts subject to normal wear, this includes bushings, bump stops, ball joints, tie rod ends and heim joints
 - Discontinued products at Pro Comp's discretion
- Bent or dented product
- Finish after 90 days
- Leaf or coil springs used without proper bump stops
- Light bulbs
- Products with evident damage caused by abrasion or contact with other items
- Damage caused as a result of not following recommendations or requirements called out in the installation manuals
- Products used in applications other than listed in Pro Comp's catalog
- Components or accessories used in conjunction with other manufacturer's systems
- Tire & Wheel Warranty as per Pro Competition Tire Company policy
- Warranty claims without "Proof of Purchase"
- Pro Comp Pro Runner coil over shocks are considered a serviceable shock with a one-year warranty against leakage only. Rebuild service and replacement parts will be available and sold separately by Pro Comp. Contact Pro Comp for specific service charges.
- Pro Comp accepts no responsibility for any altered product, improper installation, lack of or improper maintenance, or improper use of our products.

E-Mail: tech@explorerprocomp.com
Website: www.explorerprocomp.com
Fax: (619) 216-1474
Ph: (619) 216-1444

PLACE WARRANTY REGISTRATION NUMBER HERE: _____
