



102 S. Michigan Ave., Coldwater, MI 49036

Phone: 517-279-2135

Web/live chat: www.bds-suspension.com

E-mail: tech@bds-suspension.com

Part#: **014350, 014200**

Product: **Complete Box Kit**

Application: **Jeep Wrangler YJ**

READ AND UNDERSTAND ALL INSTRUCTIONS AND WARNINGS PRIOR TO INSTALLATION OF SYSTEM AND OPERATION OF VEHICLE.

SAFETY WARNING BDS Suspension Co. recommends this system be installed by a professional technician. In addition to these instructions, professional knowledge of disassembly/ reassembly procedures and post installation checks must be known.

PRODUCT SAFETY WARNING Certain BDS Suspension products are intended to improve off-road performance. Modifying your vehicle for off-road use may result in the vehicle handling differently than a factory equipped vehicle. Extreme care must be used to prevent loss of control or vehicle rollover. Failure to drive your modified vehicle safely may result in serious injury or death. BDS Suspension Co. does not recommend the combined use of suspension lifts, body lifts, or other lifting devices.

You should never operate your modified vehicle under the influence of alcohol or drugs. Always drive your modified vehicle at reduced speeds to ensure your ability to control your vehicle under all driving conditions. Always wear your seat belt.

PRE-INSTALLATION NOTES

1. Special literature required: OE Service Manual for model/year of vehicle. Refer to manual for proper disassembly/ reassembly procedures of OE and related components.
2. Adhere to recommendations when replacement fasteners, retainers and keepers are called out in the OE manual.
3. Larger rim and tire combinations may increase leverage on suspension, steering, and related components. When selecting combinations larger than OE, consider the additional stress you could be inducing on the OE and related components.
4. Post suspension system vehicles may experience drive line vibrations. Angles may require tuning, slider on shaft may require replacement, shafts may need to be lengthened or trued, and U-joints may need to be replaced.
5. Secure and properly block vehicle prior to installation of BDS Suspension components. Always wear safety glasses when using power tools.
6. If installation is to be performed without a hoist, BDS Suspension Co. recommends rear alterations first.
7. Due to payload options and initial ride height variances, the amount of lift is a base figure. Final ride height dimensions may vary in accordance to original vehicle attitude. Always measure the attitude prior to beginning installation.

POST-INSTALLATION WARNINGS

1. Check all fasteners for proper torque. Check to ensure for adequate clearance between all rotating, mobile, fixed, and heated members. Verify clearance between exhaust and brake lines, fuel lines, fuel tank, floor boards and wiring harness. Check steering gear for clearance. Test and inspect brake system.
2. Perform steering sweep to ensure front brake hoses have adequate slack and do not contact any rotating, mobile or heated members. Inspect rear brake hoses at full extension for adequate slack. Failure to perform hose check/ replacement may result in component failure. Longer replacement hoses, if needed can be purchased from a local parts supplier.
3. Perform head light check and adjustment.
4. Re-torque all fasteners after 500 miles. Always inspect fasteners and components during routine servicing.

PARTS LIST

Part #	Qty	Description
YJBS	4	Bump Stop Extensions (014350 only)
BP014350	1	Bolt Pack
	2	5/16" USS washer
	2	3/8" USS washer
	1	3/8"-16 x 1" bolt
	1	3/8"-16 prevailing torque nut
	1	5/16"-18 x 1" bolt
	1	5/16"-18 prevailing torque nut
	2	1/4"-20 x 1" bolt
	2	1/4"-20 prevailing torque nut
	4	1/4" USS flat washer
	6	1/2"-13 x 3" bolt
	2	12mm-1.75 x 70mm bolt
	1	12mm-1.75 x 60mm bolt
	3	12mm-1.75mm prevailing torque nut
	6	7/16" USS flat washer
	1	1/8" x 1-1/2" cotter pin
	2	7/16" SAE flat washer
	1	7/16"-14 x 1-1/4" bolt
	1	7/16"-14 prevailing torque nut

Brake Line Brackets

T86FBB	1	Rear "Z" Shaped Brake Line Bracket
YJBB-P	1	Front Brake Line Drop Bracket PS
YJBB-D	1	Front Brake Line Drop Bracket DS

Spring Components

3624RB	16	Spring Eye Bushings
15	4	0.750 x 0.083 x 2.950 Sleeve
37	4	0.750 x 0.109 x 2.985 Sleeve
2124	2	4 Degree Shims (014350 only)

Sway Bar Links (014350 Only)

92025	2	Anti-Sway Bar Extension Links (014350 only)
SB58RB	8	Sway Bar Bushings (014350 only)

Track Bar Brackets

931203	1	Front "L" Shaped Track Bar Bracket
940101	1	Rear "U" Shaped Track Bar Bracket
5	1	7/8 X .156 X 1.675" Sleeve

Transfer Case Drop

01837	2	Transfer Case Drop Spacer
200-03369	4	Spacer Tube End Cap
YJTC6	6	Transfer Case Drop Conical Washer
B12X3G5	6	1/2"-13 x 3" Transfer Case Bolt
W76USS	6	7/16" Flat Washer

U-Bolts

N12FH	16	1/2" High Nut
W12S	16	1/2" Flatwashers
122120634R	6	1/2 x 2-1/2 x 6-3/4" U-Bolt
123250700R	2	1/2 x 3-1/4 x 7" U-Bolt

INSTALLATION INSTRUCTIONS

1. Disconnect the track bar from the axle by removing and retaining the OE fastener.
2. Raise vehicle and place jack stands under frame in the appropriate positions, front and rear. Remove wheels and shocks.
3. Disconnect the lower ends of anti-sway bar links, driver and passenger side. Note: OE links will be reused with the 2" kit; BDS replacement links are supplied for the 3.5" kit. Remove fasteners holding brake line anchors to frame on the driver's and passenger's side. The supplied front brake line relocation bracket is a small plate about 1" wide with a slight tab bent up at an angle. Mount brake line extensions to existing holes in frame with the bends pointed down and forward. Carefully manipulate brake line tubing to allow reattachment to the brake line extensions.
4. Support the differential. Remove u-bolts and u-bolt mounting plates. Remove spring mounting bolts. Remove springs. (Fig. 1)

5. Install bushings and sleeves supplied in to the new spring eyes. Note: shackle end of spring uses the 1/2" I.D. sleeve while the hanger/anchor end uses the 9/16" I.D. sleeve. BDS #004200 -2" spring fits both front and rear; BDS #004351 -3.5" front spring and BDS # 004359 -3.5" rear spring are not interchangeable.
6. Clean the spring-to-axle mating points. Lower the jack/axle on to the springs. Be sure center bolt heads align and seat properly into the spring perch holes.

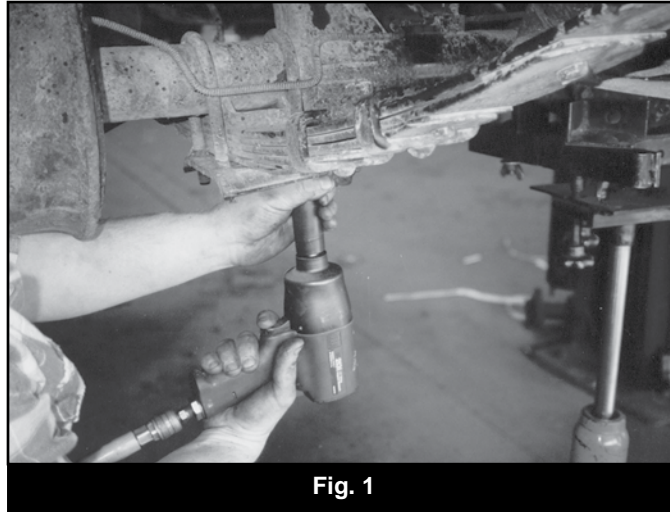

7. Position u-bolt plates and install the new u-bolts, washers, nuts and new bump stop contacts. These are retained to the axle by the outer most u-bolts on each side.
 - ⓘ *Note: The BDS 3.5" YJ box kit #014350 includes these. The 2" system, box kit #014200, does not include or require bump stop contacts.*
 - ⓘ *Note: If pitman arm (BDS Part #084404 for power steering only) is replaced, install now.*
8. Temporarily attach the new track bar bracket to the axle with the 12mm x 60mm bolt, nut and 7/16" USS washers provided. The offset in the plate will go up and the tab with a slotted hole will fit in between the casting webs.
9. Mark the location of the slotted hole using the bracket as a template. (Fig. 2A)
10. Remove the bracket and drill a 7/16" hole and the mark through the track bar axle mount.
 - ⓘ *Note: It may be necessary to disconnect the steering stabilizer from the axle to allow for drill clearance.*
11. Reattach the new bracket to the axle with the 12mm hardware. Also attach the bracket through the newly drilled hole with a 7/16" x 1-1/4" bolt, nut and 7/16" SAE washer. Torque 7/16" and 12mm hardware to 50 ft-lbs. (Fig. 2B)

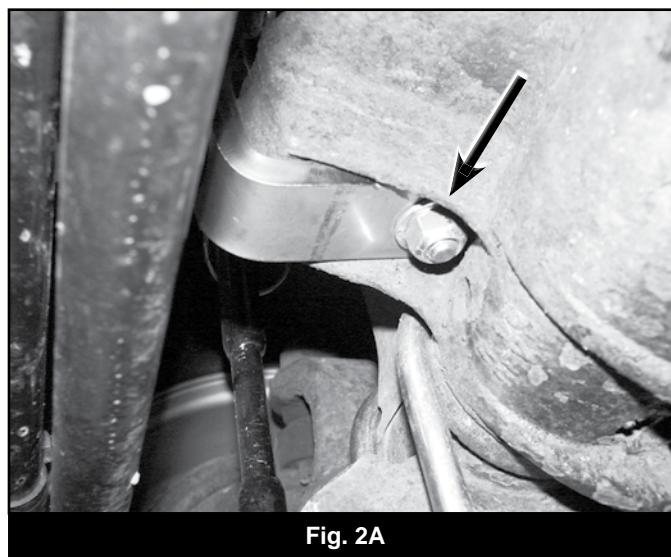



Fig. 2B

12. Install recommended replacement BDS shocks. Install tires and wheels.
13. With the suspension unloaded and hanging, cycle steering lock to lock, while manually spinning wheels. Inspect steering, suspension, and driveline for proper operation, clearance, and length. Pay close attention to brake and axle vent hoses.
14. Remove front jack stands and lower vehicle to ground. Reattach OE anti-sway bar links when installing BDS #004200 -2" springs. Install new links and bushings (included in box kit #014350). (Fig. 3) Insert mount pins in the new links and install; torque to spec. Torque to 65 ft.lbs.

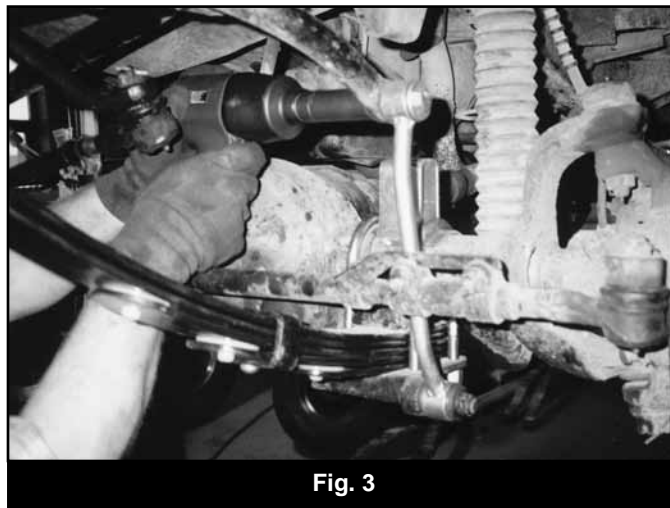

Fig. 3

15. Bounce the front of the vehicle to settle the suspension. Torque the u-bolts to 70-85 ft.lbs. Torque the 9/16" hanger bolts to 95 ft.lbs. and the 1/2" shackle bolts to 65 ft.lbs. Attach the track bar to the track bar relocation bracket with a 12mm x 70mm bolt, nut and 7/16" USS washers from bolt pack #904. Turn the steering wheel to help align the holes. If necessary the track bar can be loosened at the frame to provide extra movement. Torque track bar bolts to 55 ft. lbs.

Transfer Case Lowering Kit

16. Support the transfer case skid plate with a floor jack.
17. Locate both of the transfer case drop spacer tubes and the (4) plastic caps. Lightly tap the caps squarely into the ends of the spacer tubes until fully seated.
18. Loosen but do not remove all six skid plate mounting bolts.
19. Remove the three bolts on the drivers's side mounting the skid plate to the frame. Slowly lower the jack until one of the spacers tubes can be installed between the skid plate and the frame. With the large holes facing up, line up the holes at each mounting bolt location.

20. Attach the skid plate and transfer case drop with the provided 1/2" x 3" bolts, 7/16" USS washers, and conical washers YJTC6 (Fig 4). Leave bolts loose.

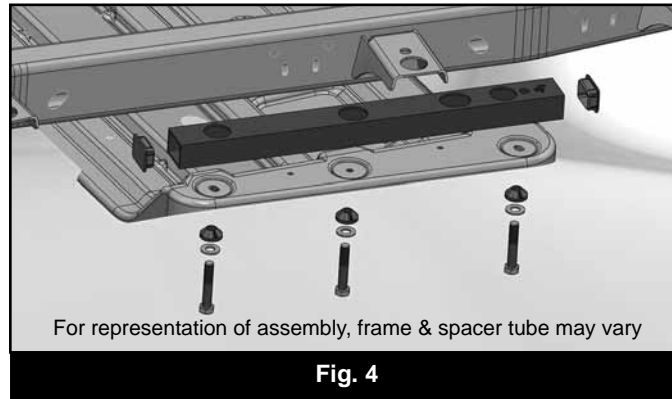

21. Repeat the procedure for the passenger's side of the skid plate.
22. With all six bolts/spacer installed, torque the bolts to 65 ft-lbs.
23. Check for any restriction of the manual transmission shifter and transfer case lever and remedy. It may be necessary to move the boot rearward and/or notch floor to eliminate restriction or component failure may result.

YJ REAR INSTALLATION

24. Remove wheels and shocks. Disconnect the track bar from the axle. Remove the brake hose clip retaining the hose anchor to frame. Note: This is located on the driver's side behind the driver's side upper shock mount. Use a 3/8 x 1" bolt, flat washers and lock nut to mount the extension bracket to hanger with the bend down. Carefully acquire slack in hard line and reattach hose anchor to extension bracket using OE clip. DO NOT kink or damage line. (Fig. 5)

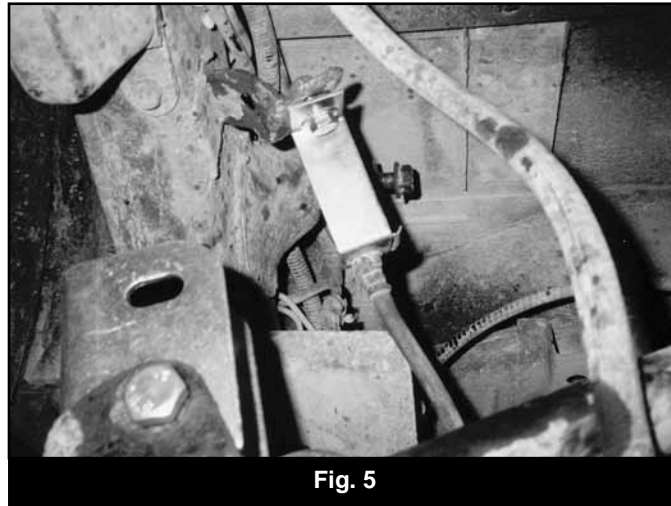

25. Support differential; remove spring mounting bolts, u-bolts and remove springs.
26. Lubricate the new spring bushings and install in spring eyes.
- ⓘ Note: The shackle end of the spring, BDS #004359 -3.5" rear or BDS #004200 -2" rear, receives the 1/2" ID x 3" sleeve, the stationary end receives the 9/16 x 3" sleeve.
27. Clean the spring-to-axle mating points. Lower the jack/axle onto the springs. Be sure the center bolt heads align and seat properly into the spring perch holes. **Note:** On 3.5" lift insert the 4 degree shim between axle and spring with the thick end pointed toward front of vehicle. The hole in the shim is small so that it can be bolted directly to the leaf pack via the center pin. A longer center pin may be required. If the center pin head is tall enough to pass through the shim, you can drill out the shim hole to set around the center pin head.
28. Position u-bolt plates and install the new u-bolts, washers and nuts along with the new bump stop contact extensions. These are retained by the outer u-bolts. **Note:** BDS 3.5" YJ box kit #014350 includes these. The 2" BDS system, box kit #014200, does not require or include bump stop contacts. (Fig. 6)

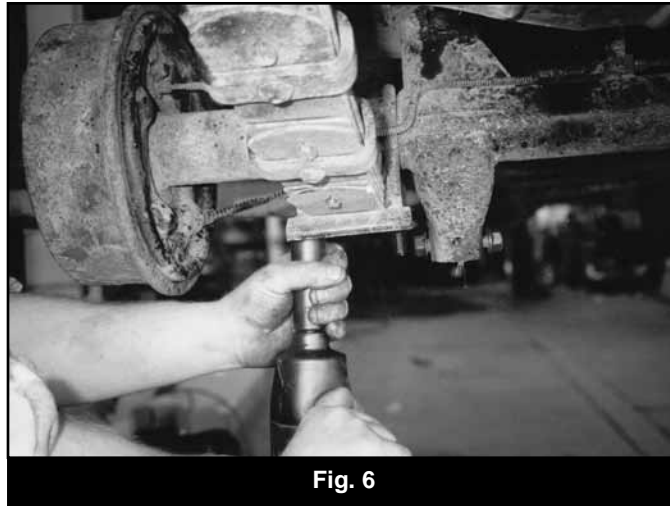

Fig. 6

29. Place 1/2" ID x 1 5/8" sleeve in track bar extension bracket at the 1/2" ID hole to retain spacing. Retain loosely with 12mm x 70mm bolt. Install 5/16" x 1" bolt, with washers and lock nut in the lower outside hole. Torque the 5/16" then the 12mm bolt. Mount track bar using the OE fastener. It may be necessary to loosen the mount at the frame. Do not torque fasteners at this time. (Fig. 7)

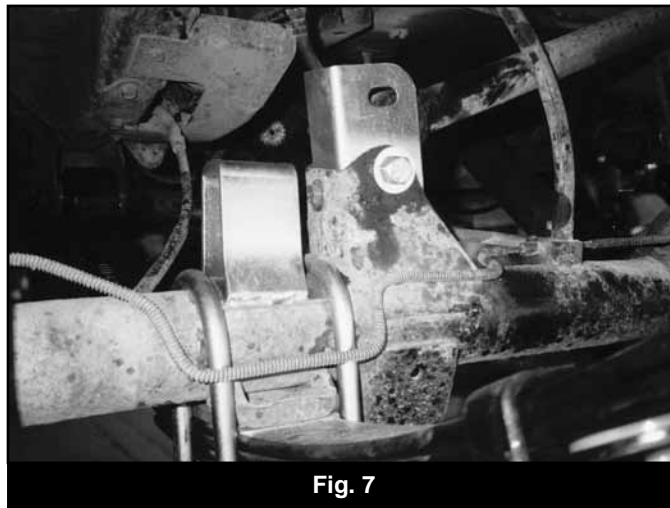

Fig. 7

30. Install replacement BDS shocks. Install tires and wheels.
31. With suspension unloaded and hanging, while manually spinning the wheels, inspect suspension, and driveline for proper operation, clearances, and lengths. Pay close attention to brake and axle vent hoses.
32. Bounce the rear of the vehicle to settle the suspension. Torque the u-bolts to 70-85 ft.lbs. Torque the 9/16" hanger bolts to 95 ft.lbs. and 1/2" shackle bolts to 65 ft. lbs.
33. Drive vehicle to allow all components to center in their mounts. Torque the two remaining transfer case mount bolts to specification.
34. This procedure should insure no drive line vibration. Alignment angles will be affected by installation of a suspension lift. We suggest an alignment be performed to ensure proper handling and tire wear.

NOTICE TO DEALER/INSTALLER

These instructions, the warning card, and included decals must be given to the owner of this BDS Suspension product.

For questions, technical support and warranty issues relating to this BDS Suspension product, please contact your distributor/installer before contacting BDS Suspension directly.

Sold/Installed by: