



## **INSTALLATION INSTRUCTIONS**



**2015-17 FORD F150 4WD**

**FTS22177 - 4" BASIC SYSTEM**

**FTS22178 - 4" PERFORMANCE SYSTEM**

**FT22176i**

**Fabtech Motorsports** | 4331 Eucalyptus Ave. Chino, CA 91710

**Tech Line:** 909-597-7800 | **Fax:** 909-597-7185 | **Web:** [www.fabtechmotorsports.com](http://www.fabtechmotorsports.com)

<b>K2193 4" BASIC W/ REAR PERFORMANCE SHOCKS</b>		
1	FTS22176	COMPONENT BOX 1
1	FTS22177	COMPONENT BOX 2
2	FTS7266	REAR PERFORMANCE SHOCKS

<b>K2193M 4" BASIC W/ REAR STEALTH SHOCKS</b>		
1	FTS22176	COMPONENT BOX 1
1	FTS22177	COMPONENT BOX 2
2	FTS6063	REAR STEALTH SHOCKS

<b>K2193DL 4" PERFORMANCE W/ DIRT LOGIC SHOCKS</b>		
1	FTS22176	COMPONENT BOX 1
1	FTS22178	COMPONENT BOX 2
1	FTS22185	2.5" DIRT LOGIC COILOVERS N/R (PAIR)
2	FTS810292	2.25" DIRT LOGIC NON RESI

<b>K2196DL 4" PERFORMANCE W/ DIRT LOGIC RR SHOCKS</b>		
1	FTS22176	COMPONENT BOX 1
1	FTS22178	COMPONENT BOX 2
1	FTS22185	2.5" DIRT LOGIC COILOVERS W/RESI (PAIR)
2	FTS810292	2.25" DIRT LOGIC NON RESI

<b>FTS22176 COMPONENT BOX 1</b>		
1	FT30377BK	SKID PLATE
1	FT30592BK	FRONT CROSSMEMBER 4"
1	FT30593BK	REAR CROSSMEMBER 4"
2	FT30491	DIFF DROP BRACKET UPPER
1	FT30621	SWAY BAR DROP BRACKET (PASSENGER)
1	FT30622	SWAY BAR DROP BRACKET (DRIVER)
1	FT30625	HARDWARE KIT

<b>FTS22177 COMPONENT BOX 2 - BASIC SYSTEM</b>		
2	FT292	ALIGNMENT CAM KIT
1	FT30618	HARDWARE SUBASSEMBLY
4	FT350U	UBOLTS
2	FTBK22	BLOCK 2.25"
1	FT30617D	SPINDLE (DRIVER)
1	FT30617P	SPINDLE (PASSENGER)
2	FTS30503	4" COILOVER

<b>FTS22178 COMPONENT BOX 2 - PERFORMANCE SYSTEM</b>		
2	FT292	ALIGNMENT CAM KIT
1	FT30618	HARDWARE SUBASSEMBLY
4	FT350U	UBOLTS
2	FTBK22	BLOCK 2.25"
1	FT30617D	SPINDLE (DRIVER)
1	FT30617P	SPINDLE (PASSENGER)

<b>FT30618 HARDWARE SUB-ASSEMBLY</b>		
1	FT22176i	INSTRUCTIONS
1	FT30619BK	REAR CROSSMEMBER DIFF PLATE
2	FT30496	FRONT BRAKE LINE BRACKET
1	FT70033	REAR BRAKE LINE BRACKET
1	FTAS12	STICKER FT BLUE 10X4
1	FTAS16	DRIVER WARNING DECAL
1	FTREGCARD	REGISTRATION CARD
1	FT30610	5/16" X 4" HOSE

<b>FT30625 - HARDWARE KIT</b>		<b>LOCATION</b>
<b>BAG 1</b>		
4	5/16 SAE WASHER G5 ZINC	BRAKE LINE
2	5/16-18 STOVER NUT G5 Z1	
2	5/16-18 X 1 HEX BOLT G8 ZINC	
8	7/16 SAE WASHER G5 ZINC	SWAY BAR EXT
4	7/16-14 C-LOCK NUT ZINC	
4	7/16-14 X 1-1/4 HEX BOLT G8 ZNC	
4	1/2-13 X 3" HEX BOLT G8 ZNC	LOWER SHOCK
8	1/2 SAE WASHER G8 ZINC	
4	1/2-13 C-LOCK NUT ZINC	
<b>BAG 2</b>		
1	1/2-13 X 1-3/4 HEX BOLT G8 ZINC	CENTER DIFF
4	1/2-13 X 4" HEX BOLT G8 ZNC	DIFF MOUNT
16	1/2 SAE WASHER G5 ZINC	DIFF MOUNT/ SKID
8	1/2-13 C-LOCK NUT ZINC	
3	1/2-13 X 1-1/4 HEX BOLT G8 ZNC	SKID PLATE
3	M10-1.5 X 45MM HEX BOLT	CENTER DIFF
3	10MM SPLIT WASHER	
3	M10 FLAT WASHER ZINC	
1	M18-2.5 X 150MM HEX BOLT	REAR CROSSMEMBER
2	M18 FLAT WASHER	
1	M18-2.5	
2	3/8-16 X 1" HEX BOLT	CROSSMEMBER PLATE
4	3/8" SAE FLAT WASHER	
2	3/8-16 C-LOCK NUT	
<b>BAG 3</b>		
2	5/16 SAE WASHER G5 ZINC	REAR BRAKE LINE
1	5/16-18 STOVER NUT	
1	5/16-18 X 1 HEX BOLT	
8	9/16" SAE WASHER	UBOLTS
8	9/16-18 NYLOCK NUT	
2	THREAD LOCKING COMPOUND 1 MIL	



## - PRE-INSTALLATION NOTES -

**For technical assistance call: 909-597-7800 or e-mail: info@fabtechmotorsports.com**

### *Read this before you begin installation-*

Check all parts to the parts list above before beginning installation. If any parts are missing contact Fabtech at 909-597-7800 and a replacement part will be sent to you immediately.

Read all instructions thoroughly from start to finish before beginning the installation. If these instructions are not properly followed severe frame, driveline and / or suspension damage may occur.

Check your local city and state laws prior to the installation of this system for legality. Do not install if not legal in your area.

Prior to the installation of this suspension system perform a front end alignment and record. Do not install this system if the vehicle alignment is not within factory specifications. Check for frame and suspension damage prior to installation.

The installation of this suspension system should be performed by two professional mechanics.

Use the provided thread locking compound on all hardware.

Do not combine this suspension system with any other lift device or parts.

This suspension must be installed with Fabtech shock absorbers.

**WARNING-** Installation of this system will alter the center of gravity of the vehicle and may increase roll over as compared to stock.

On EcoBoost 3.5L and 2.7L models, discard all air shields.

OEM Wheels and tires cannot be used after the installation of this kit. Larger tires cannot be installed on the OEM wheels.

Verify differential fluid is at manufacture's recommended level prior to kit installation. Installation of the kit will reposition the differential and the fill plug hole may be in a different position. (For example, if the manufacture recommends 3 quarts of fluid, make sure the diff has 3 quarts of fluid). Check your specific manual for correct amount of fluid.

## **FACTORY FORD SPECIFICATIONS FOR 4 WHEEL DRIVE USE**

**NOTE: Do not use 4H or 4L mode on dry, hard surfaced roads. Doing so can produce excessive noise, increase tire wear and may damage drive components. 4H or 4L mode is only intended for consistently slippery or loose surfaces. Use of 4L mode on these surfaces may produce some noise (such as occasional clunks), but will not damage drive components.**

**4H (4X4 HIGH) - Used for extra traction such as in snow or icy roads or in off road situations. This mode is not intended for use on dry pavement.**

**4L (4X4 LOW) - Uses extra gearing to provide maximum power to all four wheels at reduced speeds. Intended only for off-road applications such as deep sand, steep grades, or pulling heavy objects. 4L (4x4 low) will not engage while your vehicle is moving above 3 mph; this is normal and should be no reason for concern.**

### *Recommend Tires and Wheels:*

Use 33/12.50R18 tires w/ 18x9 wheels w/ 5" BS w/ minor trimming

Use 33/12.50R20 tires w/ 20x9 wheels w/ 5" BS w/ minor trimming

### **- TOOL LIST -**

#### **Required Tools (Not Included)**

Floor Jack, Jack Stands, Torque Wrench

Assorted Metric and S.A.E sockets, and Allen wrenches

Die Grinder w/Cut-off Wheel

1-1/2" Barrel Sand Wheel, 1/2" Barrel Sand Wheel

# - INSTRUCTIONS -

## FRONT SUSPENSION

1. Disconnect the negative terminal on the battery. Jack up the front end of the truck and support the frame rails with jack stands. **NEVER WORK UNDER AN UNSUPPORTED VEHICLE!** Remove the front tires.
2. Remove and discard the factory splash guard under the differential.
3. Locate the sway bar end links and disconnect from the factory lower control arms, save the hardware. Locate the sway bar frame mounts and disconnect them from the frame, remove the sway bar from the truck. Save the hardware and sway bar.
4. Working from the driver side of the vehicle disconnect the brake line and ABS line from the factory knuckle. **SEE FIGURE 1**



FIGURE 1 - STEP 4

5. Disconnect the tie rod ends from the steering knuckle by striking the knuckle to dislodge the tie rod end. **SEE FIGURE 2**

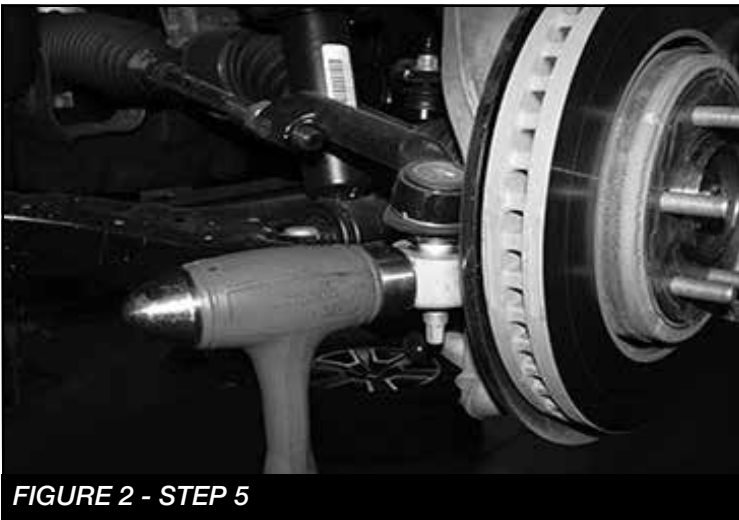


FIGURE 2 - STEP 5

6. Remove the brake caliper and place it next to the frame. Do not overstretch the brake hose when doing so. Retain the hardware for reinstallation. Remove the brake rotor and save. Disconnect the vacuum lines attached to the rear of the hub assembly. Allow the vacuum lines to hang freely. Remove the electronic stability control (ESC) sensor from the top of the hub. Cover the sensor to keep it free from dirt and debris. **SEE FIGURE 3**



FIGURE 3 - STEP 6

7. Carefully remove the dust cap covering the hub assembly nut. Remove the C.V. bearing nut and save the nut and dust cap. Remove the dust shield and save for reinstallation. **SEE FIGURE 4**



FIGURE 4 - STEP 7

8. Remove the upper and lower ball joint nuts. Disconnect the upper and lower ball joints from the steering knuckle by striking the knuckle with a large hammer next to each ball joint on the knuckle to dislodge the ball joints. Use care not to hit the ball joints when removing. Retain hardware and remove the knuckle with the hub. Use extra care not to over extend the C.V. axle shaft when removing the knuckle. **SEE FIGURES 5-6**



FIGURE 5 - STEP 8

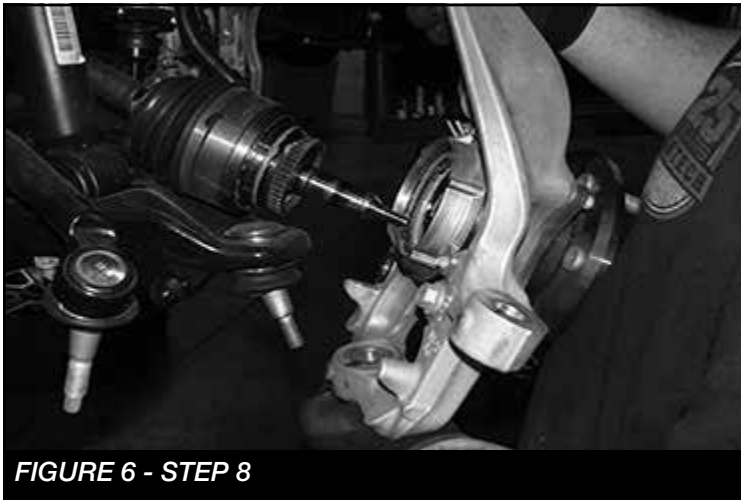


FIGURE 6 - STEP 8

9. Locate the lower shock mount bar pin nuts and remove. Loosen and remove the control arm at the crossmembers and save for re-installation. **SEE FIGURES 7-8**

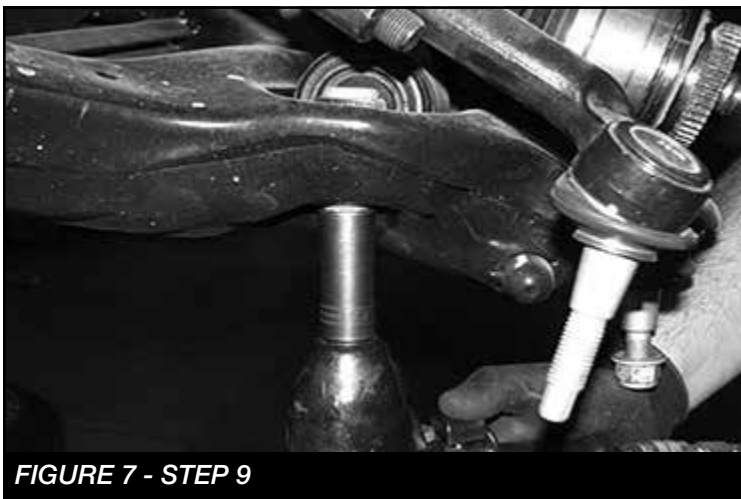


FIGURE 7 - STEP 9

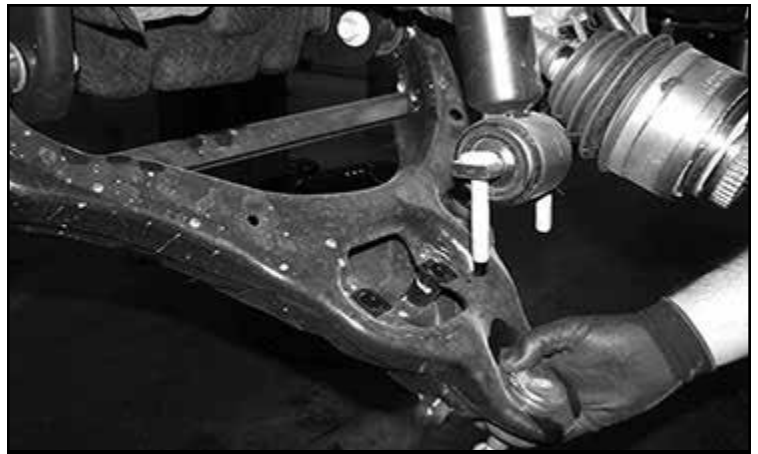


FIGURE 8 - STEP 9

10. Locate the three upper coilover nuts and remove. Save the hardware. Remove the shock assembly from the vehicle and mark "Driver" for assembly to install later with Fabtech shock extensions. **NOTE: If installing Dirt Logic coilovers the factory coilover and hardware will not be re-used. SEE FIGURE 9**

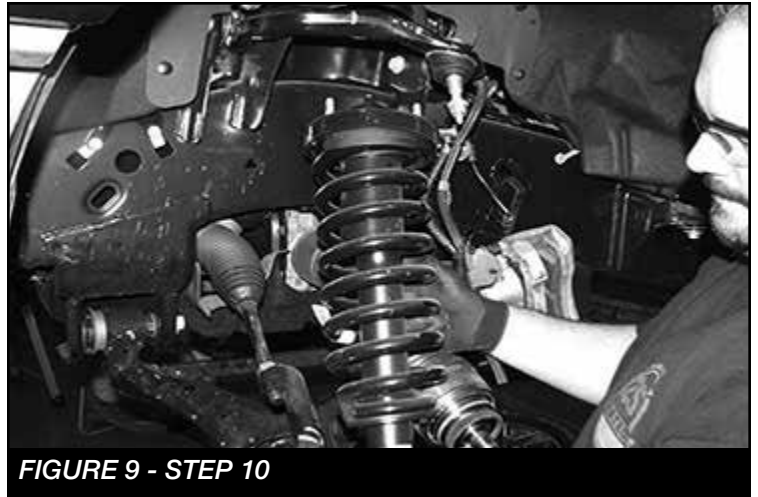


FIGURE 9 - STEP 10

11. Repeat steps 4 through 10 on the passenger side of the truck.

12. Remove the factory rear crossmember from the vehicle and discard. **NOTE: Due to variances in vehicles, the bolt attaching the crossmember and the frame on the drivers side may need to be cut off. SEE FIGURE 10-11**



FIGURE 10 - STEP 12



FIGURE 11 - STEP 12

13. Remove the front drive shaft bolts where they attach to the front differential. Support the end of the driveshaft before removing the front differential. **SEE FIGURE 12**

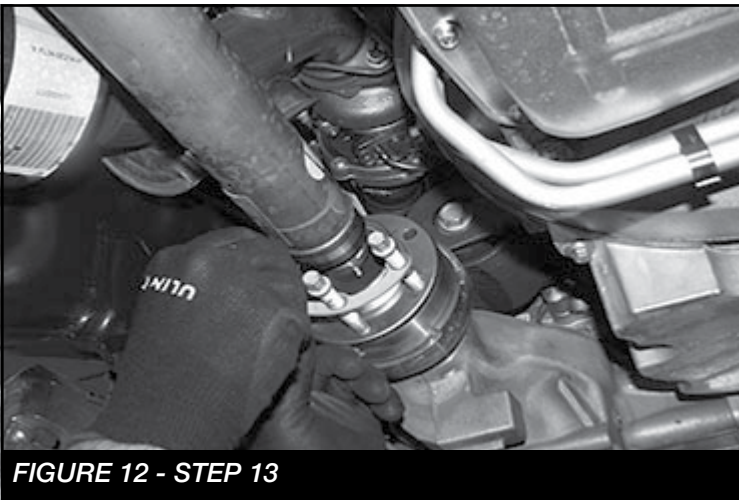


FIGURE 12 - STEP 13

14. Supporting the differential, remove the 3 differential mount bolts and save for re-installation. Remove the differential from the vehicle. **SEE FIGURE 13**

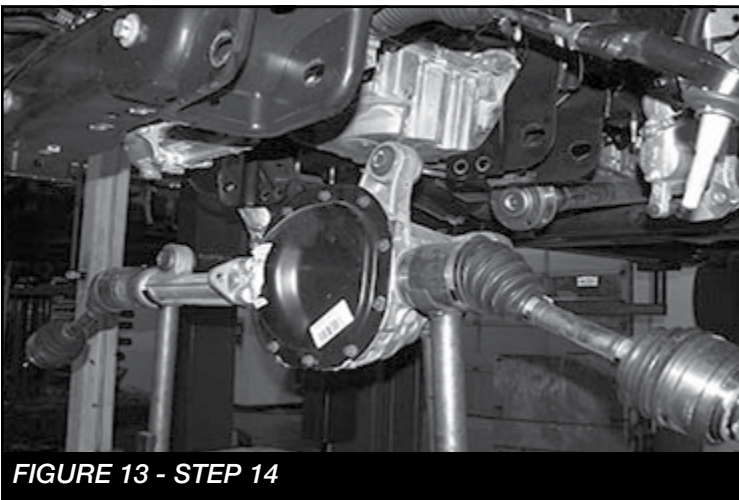


FIGURE 13 - STEP 14

15. Locate the driver side rear lower control arm pocket. Mark the frame 1-3/8" from the control arm pivot hole and 90 degrees to the bottom of the pocket where the cross member was mounted. Using a die grinder, cut all the way around the pocket. Discard removed portion of the pocket. **SEE FIGURES 14-15**

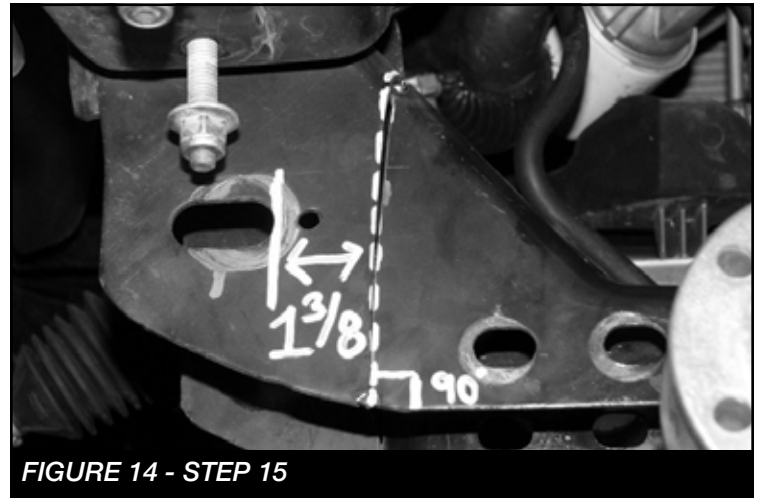


FIGURE 14 - STEP 15

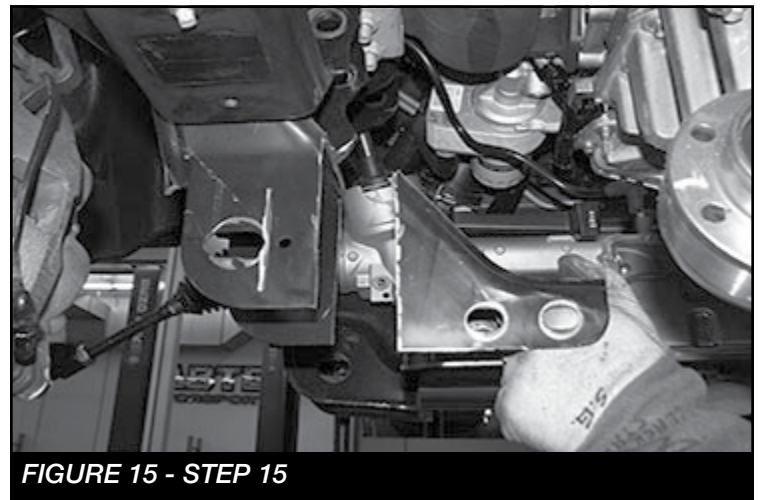


FIGURE 15 - STEP 15

16. Still working on the driver side rear lower control arm pocket, locate the tab on the pocket towards the rear of the vehicle. You will need to cut and sand a radius in the rear side of the pocket in order to clear the differential housing. **SEE FIGURE 16**

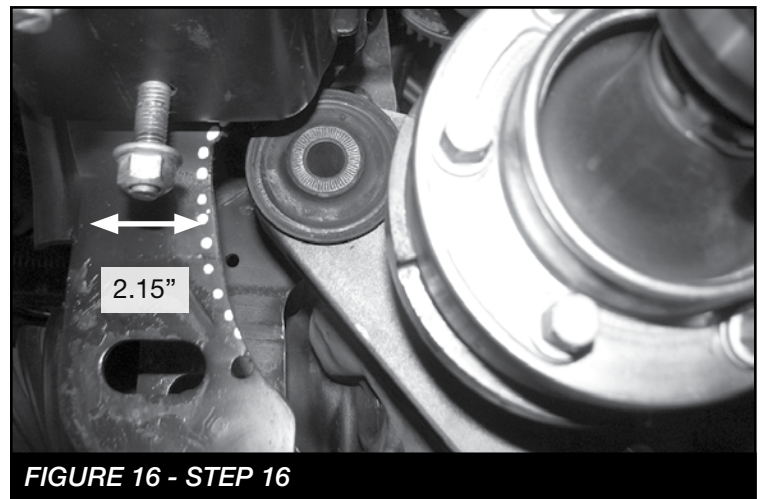


FIGURE 16 - STEP 16

17. Locate the front tab on the same mount. You will need to sand a 1/2" on the inside to clear the differential. **SEE FIGURE 17**



18. Locate the two Fabtech upper differential mounts (FT30491). These upper differential mounts will be placed into the factory upper differential mounts using the factory upper differential mount hardware. Leave the hardware loose in preparation for the differential installation. **SEE FIGURES 18**



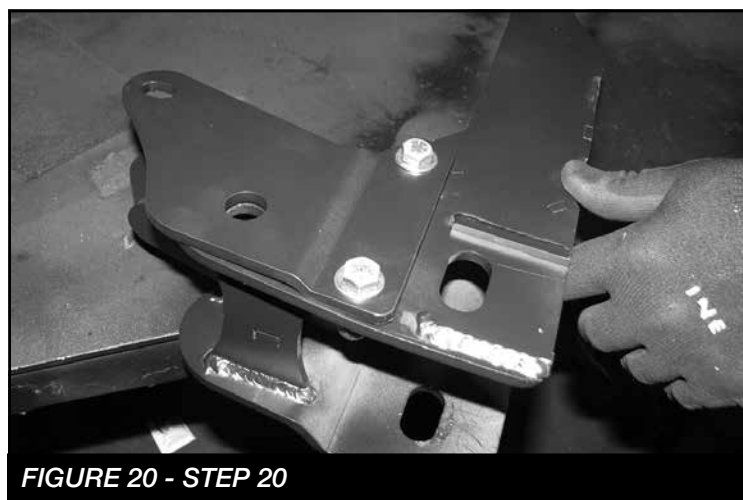
**FIGURE 18 - STEP 18**

19. Locate the factory front differential and install into the Fabtech upper differential mounts using two 1/2"-13 x 4" hex cap bolts, washers and lock nuts. Leave all hardware loose in preparation of the installation of the remaining differential mounts. **SEE FIGURE 19**



**FIGURE 19 - STEP 19**

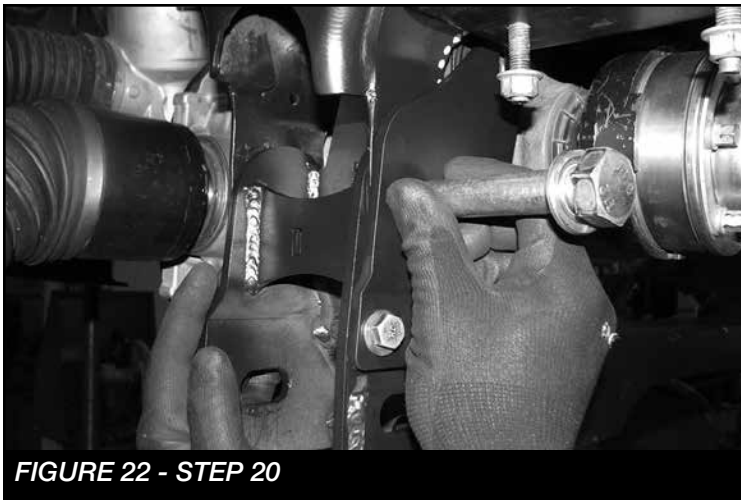
20. Locate the Fabtech rear crossmember (FT30593BK) and rear diff plate (FT30619BK). Install the rear diff plate on the rear crossmember using the 3/8" hardware. Leave loose. Install the crossmember using the 18mm and 1/2"-13 X4" hardware for the driver side and reuse the factory hardware for the passenger side. **SEE FIGURES 20-22**



**FIGURE 20 - STEP 20**

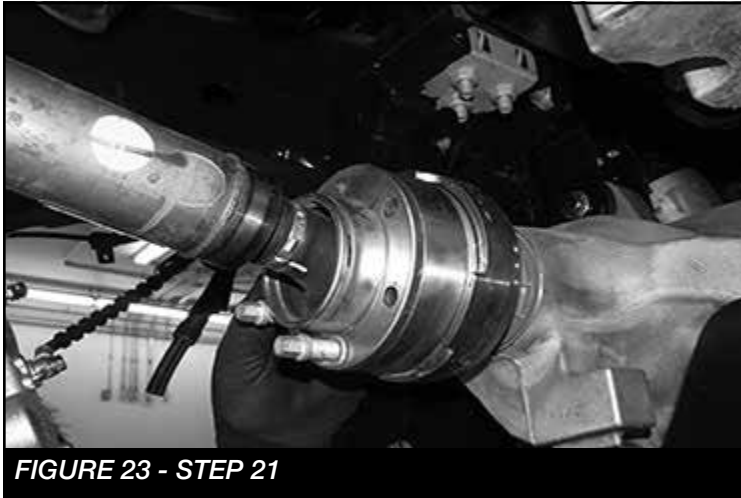


**FIGURE 21 - STEP 20**



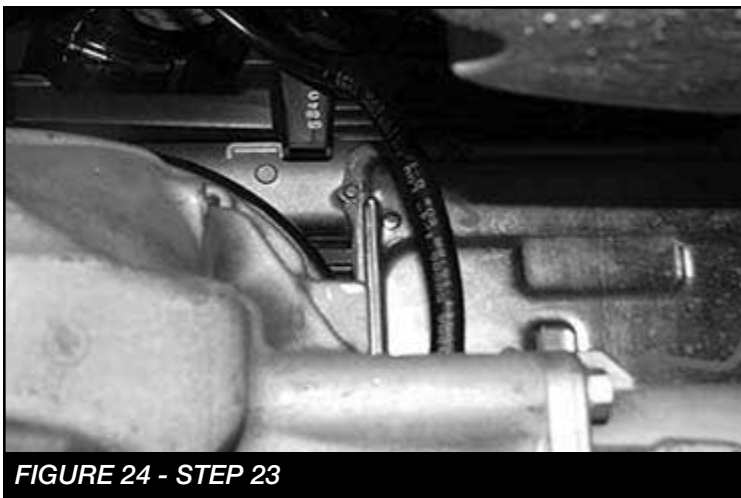
**FIGURE 22 - STEP 20**

21. Reinstall the front drive shaft with the factory hardware and torque to 35 ft-lbs. **SEE FIGURE 23**



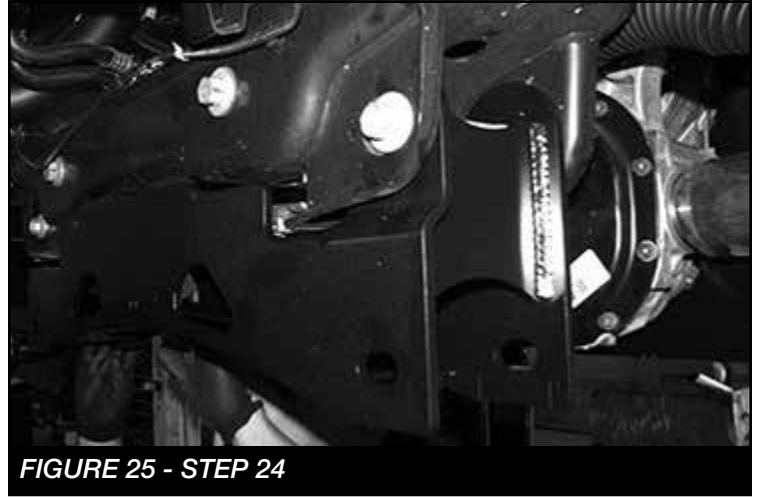
**FIGURE 23 - STEP 21**

22. Locate upper differential brackets and torque the factory upper bolts to 160 ft-lbs and lower  $\frac{1}{2}$ " bolts 127 ft-lbs. Locate the center diff mount on the cross member and torque the  $\frac{1}{2}$ "-13 x 4" bolt to 127 ft-lbs.
23. Install the supplied 4" hose to the factory differential vent tube and back on to the differential. **SEE FIGURE 24**



**FIGURE 24 - STEP 23**

24. Locate the Fabtech front crossmember (FT30592BK). Install the front crossmember into the factory front control arm pockets using the factory hardware. Make sure the skid plate tab on the crossmember is facing the Fabtech rear crossmember. Leave the hardware loose at this time. **SEE FIGURE 25**



**FIGURE 25 - STEP 24**

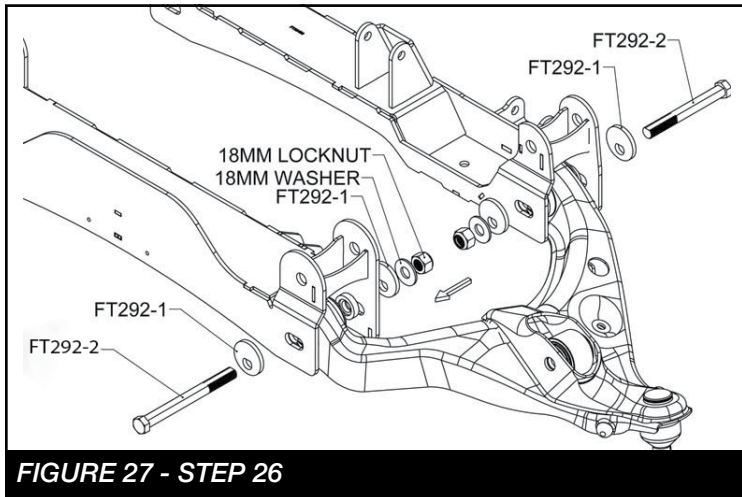
25. Locate the Fabtech skid plate (FT30377BK). The skid plate will span the distance between the front and rear crossmembers directly under the front differential. Attach the end of the skid plate with the single hole to the tab on the back side of the front crossmember using one  $\frac{1}{2}$ "- 13 x 1-1/4" bolt, washers and a C-lock nut. Leave loose at this time. Lift up the back side of the skid plate and install it to the rear crossmember using two  $\frac{1}{2}$ "- 13 x 1-1/4" bolts, washers and a C-lock nut. Torque only the 2 rear bolts at this time to 127 ft-lbs. **SEE FIGURE 26**



**FIGURE 26 - STEP 25**



26. Locate the Alignment cam kit (FT292). Locate the factory control arms. Install the lower control arms into the Fabtech crossmembers using the hardware in the cam kit (FT292). Torque the cam bolts at 200 ft-lbs after alignment. Torque crossmember bolts to 240 ft-lbs. **SEE FIGURE 27**

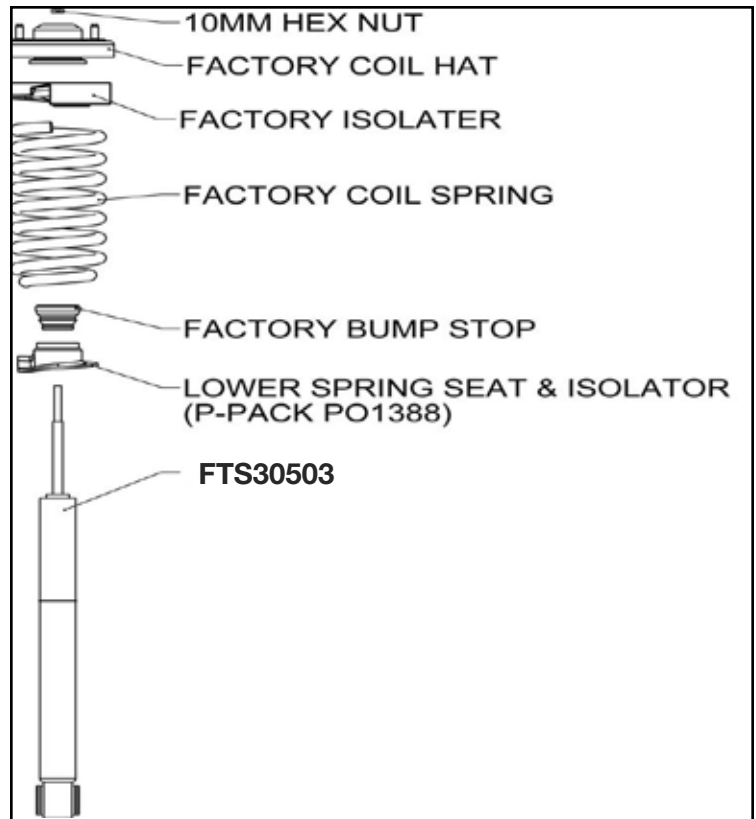


**FIGURE 27 - STEP 26**

27. If installing Dirt Logic coilovers (FTS22183 or FTS22185) do so at this time, using the instructions provided in the shock box. Once finished, skip to STEP 33

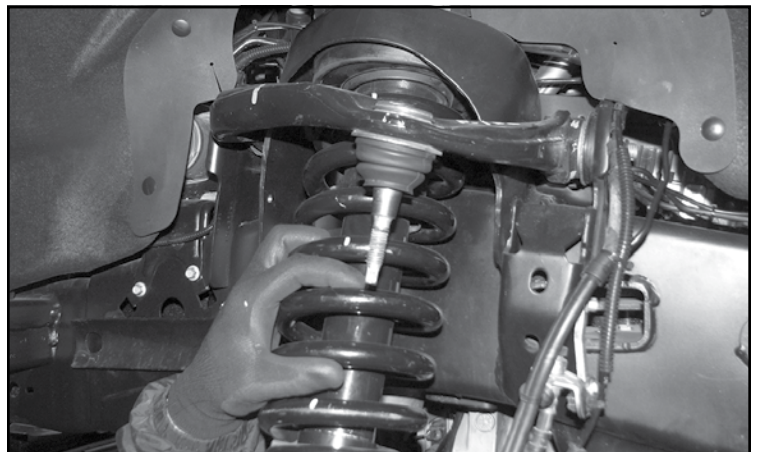
**If using FTS30503 coilover continue to STEP 29**

28. Locate the factory coilovers removed earlier.
29. Using a spring compressor, compress the factory spring and remove the top coilover center nut and cap. Next install the factory spring onto the new Fabtech coilover using the new lower isolator and re-using the factory top cap and hardware. **SEE FIGURE 28**

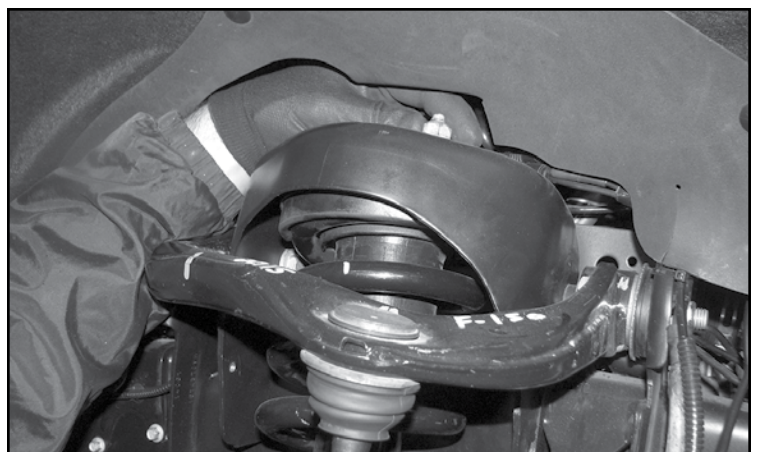


**FIGURE 28 - STEP 29**

31. Install the coil over into the frame bucket using the factory hardware. Torque 59 ft-lbs. **SEE FIGURE 29-30**



**FIGURE 29 - STEP 31**



**FIGURE 30 - STEP 31**

32. Rotate the lower control arm up and mount to the lower coilover bar pin using the supplied 1/2"-13 X 3" bolts and hardware. Torque to 127 ft-lbs. **SEE FIGURE 31**



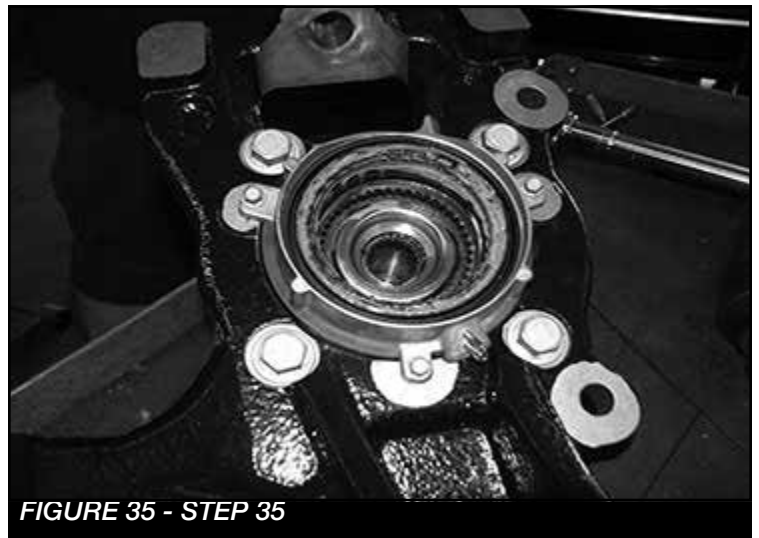
33. Locate the factory knuckle and remove the 4WD actuator and hub assembly. **SEE FIGURES 32-33** **NOTE: REFER TO FIGURE 57 ON THE LAST PAGE FOR SPECIFIC INSTRUCTIONS ON DISASSEMBLY AND ASSEMBLY OF THE 4WD ACTUATOR.**



34. Locate the Fabtech driver side spindle (FT30617D) and install the factory hub. Torque the four 14mm bolts to 160 ft- lbs. **SEE FIGURE 34**



35. Re-install the 4WD actuator using the 3 factory bolts. Torque to 29 ft-lbs. **SEE FIGURE 35**



36. Install the Fabtech knuckle onto the upper and lower control arms. **NOTE: Install the supplied spacer on the lower ball joint.** Torque the upper ball joint to 85 ft-lbs and the lower ball joint to 110 ft-lbs. **SEE FIGURE 36-37**





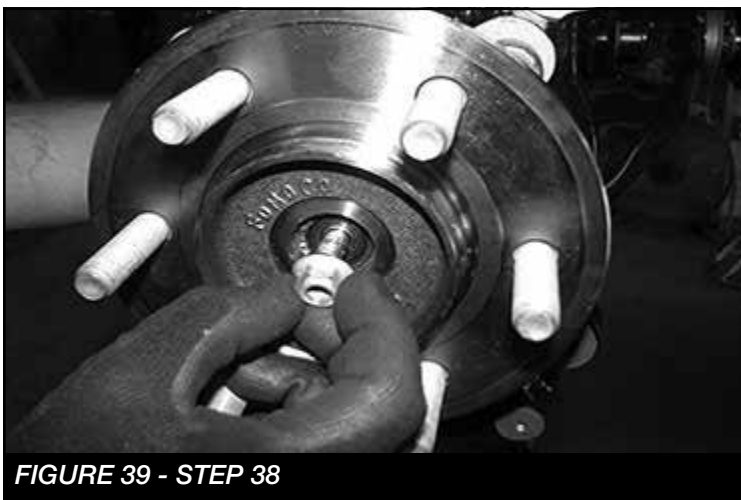
**FIGURE 37 - STEP 42**

37. Install the wheel speed sensor. Make sure the end of the sensor is clean. Torque to 21 ft-lbs **SEE FIGURE 38**



**FIGURE 38 - STEP 37**

38. Install the dust shield and torque to 14 ft-lbs. Install CV shaft nut and torque to 35 ft-lbs. Install the factory dust cover. **SEE FIGURE 39**

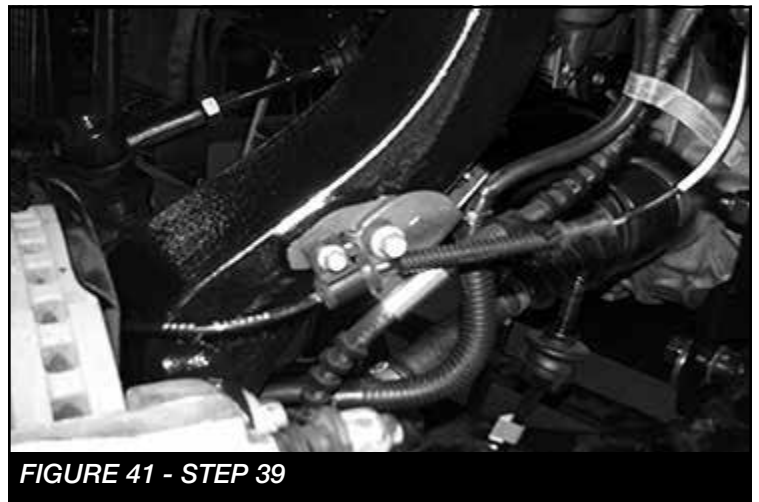


**FIGURE 39 - STEP 38**

39. Reconnect the vacuum line to the hub assembly. Using the factory bolt Install the Fabtech brake line bracket (FT30496) to the frame. Use the supplied 5/16"-18 X 1" bolts and hardware to connect the brake line to the new Fabtech bracket. Using the factory hardware, mount factory brake line bracket to the side of the Fabtech knuckle. After installing the factory brake line bracket, check to insure full movement by steering the knuckle back and forth, and make sure none of the ABS lines, brake lines, or vacuum lines are inhibited during full test movement of the knuckle. **SEE FIGURES 40-41**



**FIGURE 40 - STEP 39**



**FIGURE 41 - STEP 39**

40. Reinstall the original brake rotor, followed by the brake caliper. Use a small amount of the supplied thread lock compound on the caliper bolts and torque to 160 ft-lbs. **SEE FIGURE 42**

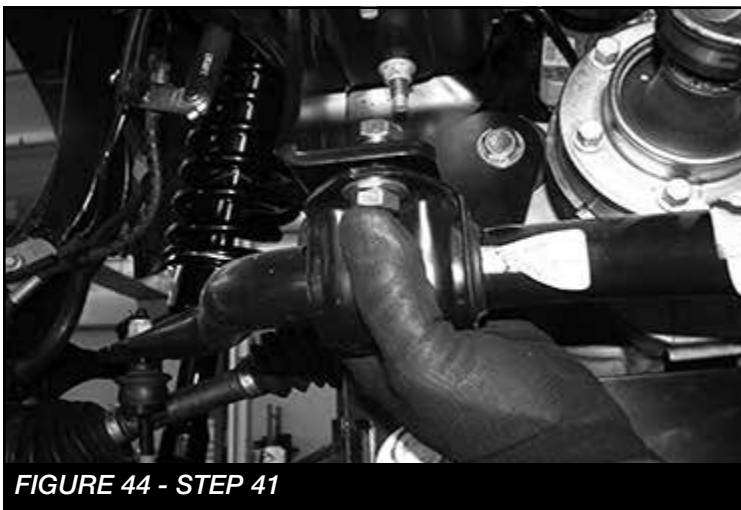


**FIGURE 42 - STEP 40**

41. Using the supplied 7/16"-14 X 1-1/4" bolts and hardware install the factory sway bar to the frame using the FT30622 driver side bracket and the FT30621 passenger side bracket. Torque to 83 ft-lbs **SEE FIGURES 43-44**



**FIGURE 43 - STEP 41**



**FIGURE 44 - STEP 41**

42. Install the sway bar end to the factory lower control arm using the factory end links. **SEE FIGURE 45**



**FIGURE 45 - STEP 42**

## **REAR SUSPENSION**

43. Jack up the rear end of the vehicle and support the frame rails with jack stands. Release the parking brake at this time. Supporting the rear differential, remove the rear shocks, u-bolts, blocks and lower axle down. Use care not to over extend the brake hose.
44. Locate the factory brake line mount on the driver side of the frame. Locate the supplied brake line bracket (FT70033) and attach the bracket between the factory frame mount and the factory brake line using the factory and supplied 5/16"-18 X 1" bolts and hardware. Torque to 29 ft-lbs **SEE FIGURE 49**



FIGURE 49 - STEP 44

45. Locate and install the rear lift blocks FTBK22. The extended bump stop perch will be facing inboard of the truck. Using the provided u-bolts, nuts and washers, align the axle, lift blocks, and springs and torque u-bolts to 184 ft-lbs. **SEE FIGURE 46**



FIGURE 46 - STEP 45

46. Locate the Fabtech performance shocks (FTS7266), Stealth shocks (FTS6063) or Dirt Logic shocks (FTS810292). Install the shocks using the factory hardware and torque upper and lower bolts to 100 ft-lbs. **SEE FIGURES 47-48**



FIGURE 47 - STEP 46

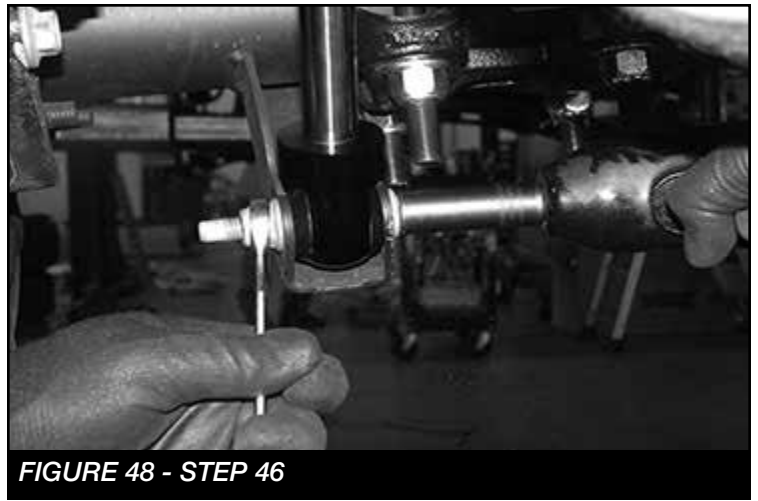


FIGURE 48 - STEP 46

47. Install tires and wheels and torque lug nuts to wheel manufacturer's specifications. Turn front tires left to right and check for appropriate tire clearance. **Note - Some oversized tires may require trimming of the front bumper & valance.**
48. Check front end alignment and set to factory specifications. Readjust headlights.
49. Recheck all bolts for proper torque.
50. Recheck brake hoses, ABS wires and suspension parts for proper tire clearance while turning tires fully left to right.
51. Check the fluid in the front and rear differential and fill if needed with factory specification differential oil. **Note - some differentials may expel fluid after filling and driving. This can be normal in resetting the fluid level with the new position of the differential/s.**
52. Install Driver Warning Decal. Complete product registration card and mail to Fabtech in order to receive future safety and technical bulletins on this suspension.

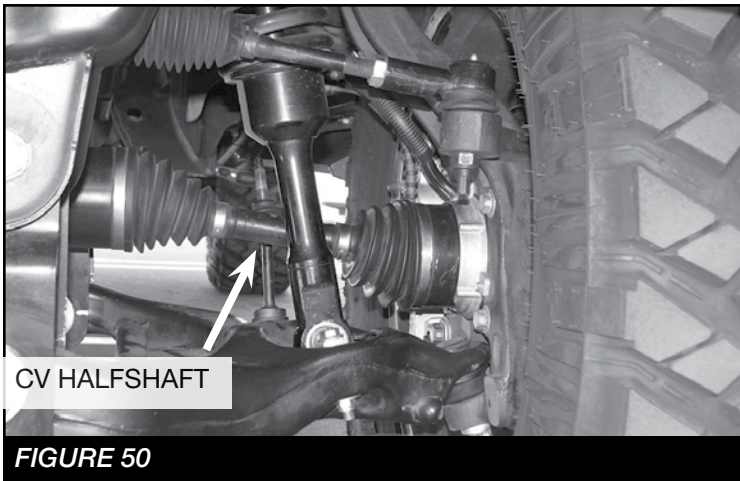
**Vehicles that will receive oversized tires should check ball joints and all steering components every 2500-5000 miles for wear and replace as required.**

**RE-TORQUE ALL NUTS, BOLTS AND LUGS AFTER 50 MILES AND THEREAFTER UNTIL FASTENERS RETAIN TORQUE SETTING.**

For technical assistance call: 909-597-7800

## Procedure for checking proper installation of HUB actuator.

- The IWE system uses vacuum hubs that engage the front wheel hubs to the front halfshafts or disengage the front wheel hubs from the front halfshafts.
  - The IWE solenoid receives engine vacuum from the vacuum reservoir.
  - When the 4-wheel drive system is in 2WD mode, the 4x4 module (PCM) supplies a ground path to the IWE solenoid to apply vacuum to the wheel ends (disengaging the front hubs from the front halfshafts). In 4WD mode, the 4x4 module (PCM) does not supply the ground path to the IWE solenoid, vacuum is not applied to the integrated wheel ends and an internal spring keeps the front hubs engaged to the front halfshafts.
1. With the vehicle on level ground. Engage the emergency brake and chalk the rear wheels.
  2. Jack up the front driver side enough so the wheel/tire spins freely.
  3. With the vehicle in PARK, start the engine. **NOTE: MAKE SURE THE VEHICLE IS PLACED IN 2WD.** Rotate the wheel/tire and check to see if the CV halfshaft rotates. If the CV halfshaft rotates, either a vacuum leak is present or the IWE (Intergrated Wheel End) was installed improperly. **NOTE: DO NOT OPERATE THE VEHICLE OR DAMAGE WILL OCCUR. SEE FIGURE 50**



4. If the CV halfshaft remains stationary when the wheel/tire is rotated repeat steps 1-3 on the front passenger wheel/tire.

**NOTE: Specific IWE “Integrated Wheel End” installation procedures are necessary when servicing and/or IWE vacuum is released. When the IWE actuator is loosened at the knuckle and/or removed from CV shaft:**

- Remove the two vacuum line, compress the IWE actuator and install a vacuum cap on the larger vacuum port (to keep it compressed).
- Install the IWE actuator onto the halfshaft outer end (if removed).
- Do not dislodge the IWE seal spring when installing an IWE on a CV halfshaft outboard end or component damage may occur.
- Allow the wheel knuckle to swing outward while keeping the halfshaft pushed inward.
- Once clearance is available, install the halfshaft outboard end into the wheel knuckle hub bearing.
- Connect the upper ball joint and install new nut; torque to 85 ft-lbs.
- Install the three IWE actuator to wheel knuckle retaining bolts; torque to 106 ft-lbs
- Remove the IWE vacuum cap and reconnect the vacuum tubes.
- Verify the spline engagement by checking for spline lash before installing the axle nut or component damage may occur.
- Install new axle nut; 30 ft-lbs

## - Product Warranty and Warnings -

Fabtech provides a Limited Lifetime Warranty to the original retail purchaser who owns the vehicle, on which the product was originally installed, for defects in workmanship and materials.

The Limited Lifetime Warranty excludes the following Fabtech items; bushings, bump stops, ball joints, tie rod ends, limiting straps, cross shafts, heim joints and driveshafts. These parts are subject to wear and are not considered defective when worn. They are warranted for 60 days from the date of purchase for defects in workmanship.

Dirt Logic and Performance Coilover take apart shocks are considered a serviceable shock with a one year warranty on leakage only. Service seal kits are available separately for future maintenance. All other shocks are covered under our Limited Lifetime Warranty.

Fabtech does not warrant any product for finish, alterations, modifications and/or installation contrary to Fabtech's instructions. Alterations to the finish of the parts including but not limited to painting, powder coating, plating and/or welding will void all warranties. Some finish damage may occur to parts during shipping, which is considered normal and is not covered under warranty.

Fabtech products are not designed nor intended to be installed on vehicles used in race applications or for racing purposes or for similar activities. (A "RACE" is defined as any contest between two or more vehicles, or any contest of one or more vehicle against the clock, whether or not such contest is for a prize). This warranty does not include coverage for police or taxi vehicles, race vehicles, or vehicles used for government or commercial purposes. Also excluded from this warranty are sales outside of the United States of America.

Installation of most suspension products will raise the center of gravity of the vehicle and will cause the vehicle to handle differently than stock. It may increase the vehicle's susceptibility to a rollover, on road and off road, at all speeds. Extreme care should be taken to operate the vehicle safely at all times to prevent rollover or loss of control resulting in serious injury or death. Fabtech front end Desert Guards may impair the deployment or operation of vehicles equipped with supplemental restraining systems/air bag systems and should not be installed if the vehicle is equipped as so.

Fabtech makes every effort to ensure suspension product compatibility with all vehicles listed on the website, but due to unknown auto manufacturer's production changes and/or inconsistencies by the auto manufacturer, Fabtech cannot be responsible for 100% compatibility, including the fitment of tire and wheel sizes listed. The Tire and Wheel sizes listed in Fabtech's website are only a guideline for street driving with noted fender trimming. Fabtech is not responsible for damages to the vehicle's body or tires. Fabtech is not responsible for premature wear of factory components due to the installation of oversized tires and wheels.

Fabtech's obligation under this warranty is limited to the repair or replacement, at Fabtech option, of the defective product only. All costs of removal, installation or re-installation, freight charges, incidental or consequential damages are expressly excluded from this warranty. Fabtech is not responsible for damages and/or warranty of other vehicle parts related or non related to the installed Fabtech product. This warranty is expressly in lieu of all other warranties expressed or implied. This warranty shall not apply to any product that has been subject to accident, negligence, alteration, abuse or misuse as determined by Fabtech.

Fabtech suspension components must be installed as a complete system including shocks as shown on our website. All warranties will become void if Fabtech parts are combined and/or substituted with other aftermarket suspension products. Combination and/or substitution of other aftermarket suspension parts may cause premature wear and/or product failure resulting in an accident causing injury or death. Fabtech does not warrant products not manufactured by Fabtech.

Depending on the condition of the factory suspension components retained after the installation of a Fabtech suspension not all vehicles may have the same ride stance front to rear as described in the website. The blue color of suspension components shown in all Fabtech photographs are for display purposes only. Majority of all Fabtech components will be black specifically where noted with part numbers ending in BK.

Installation of Fabtech product may void the vehicles factory warranty; it is the consumer's responsibility to check with their local vehicle's dealer for warranty disposition before the installation of the product. Some state laws may prohibit modification of suspension to a vehicle in whole or in part. It is the responsibility of the installer and consumer to consult local laws prior to the installation of any Fabtech suspension product to comply with such written laws.

It is the responsibility of the distributor and/or the retailer to review all warranties and warnings of Fabtech products with the consumer prior to purchase.

Fabtech reserves the right to super cede, discontinue, change the design, finish, part number and/or application of parts when deemed necessary without written notice. Fabtech is not responsible for misprints or typographical errors within the website or price sheet. For the most recent Product Warranty and Warnings visit our website [www.fabtechmotorsports.com](http://www.fabtechmotorsports.com)