



Installation Instructions



*6" Performance Suspension System
FTS23021BK/FTS23008BK/FTS23009BK
2006-08 Dodge 1500 4WD*

Fabtech Motorsports
4331 Eucalyptus Ave. Chino, CA 91710
Tech Line 909-597-7800 Fax 909-597-7185 Web www.fabtechmotorsports.com



www.fabtechmotorsports.com

*6" 2006-08 Dodge 1500 4WD
FTS23021BK / FTS23008BK*

TOOL LIST: (NOT INCLUDED)

- FLOOR JACK & JACK STANDS
- ASSORTED METRIC AND S.A.E SOCKETS & WRENCHES
- TORQUE WRENCH
- DIE GRINDER WITH CUT OFF WHEEL AND GRINDING WHEEL
- LARGE DEAD BLOW HAMMER

SOME MODELS WILL NEED EXHAUST MODIFICATION TO CLEAR THE FRONT DRIVE SHAFT. IF YOUR TRUCK HAS THE EXHAUST UNDER THE FRONT DRIVE SHAFT IT WILL NEED MODIFICATION TO CLEAR THE FRONT DRIVE SHAFT.

**THIS SUSPENSION SYSTEM IS DESIGNED TO FIT FOUR (4WD) MODELS ONLY!
SYSTEM WILL NOT WORK ON ALL WHEEL DRIVE (AWD) MODELS**

FACTORY WHEELS CAN NOT BE REINSTALLED WITH THIS KIT.

READ ALL INSTRUCTIONS THOROUGHLY FROM START TO FINISH BEFORE BEGINNING INSTALLATION! IF THESE INSTRUCTIONS ARE NOT PROPERLY FOLLOWED, SEVERE FRAME, DRIVELINE AND / OR SUSPENSION DAMAGE MAY RESULT.

CHECK ALL PARTS INCLUDED IN THIS KIT TO THE PARTS LIST ABOVE BEFORE BEGINNING INSTALLATION OF THIS KIT. IF ANY PARTS ARE MISSING, CONTACT FABTECH AT 909-597-7800.

NOTE- PRIOR TO THE INSTALLATION OF THIS SUSPENSION SYSTEM, A FRONT END ALIGNMENT MUST BE PERFORMED AND RECORDED. DO NOT INSTALL THIS SYSTEM IF THE VEHICLE ALIGNMENT IS NOT WITHIN FACTORY SPECIFICATIONS. CHECK FOR FRAME AND SUSPENSION DAMAGE PRIOR TO INSTALLATION. THIS SUSPENSION SYSTEM DOES NOT REQUIRE WELDING FOR INSTALLATION. DO NOT WELD ANY OF THESE COMPONENTS.

VEHICLES THAT WILL RECEIVE OVERSIZED TIRES SHOULD CHECK BALL JOINTS, TIE RODS ENDS AND RACK & PINION EVERY 2500-5000 MILES FOR WEAR AND REPLACE AS NEEDED.

DO NOT ALTER THE FINISH OF THESE COMPONENTS, EXAMPLE- CHROMING, ZINC PLATING OR PAINTING. CHANGING THE FINISH CAN CAUSE STRUCTURAL FATIGUE OF COMPONENTS.

THIS SYSTEM MUST BE INSTALLED WITH FABTECH SHOCK ASBORBERS TO PREVENT POSSIBLE BALL JOINT & CV DAMAGE.

THE INSTALLATION OF THIS SUSPENSION SYSTEM SHOULD BE PERFORMED BY TWO PROFESSIONAL MECHANICS.

VERIFY DIFFERENTIAL FLUID IS AT MANUFACTURES RECOMMENDED LEVEL PRIOR TO KIT INSTALLATION. INSTALLATION OF THE KIT WILL RE-POSITION THE DIFFERENTIAL AND THE FILL PLUG HOLE MAY BE IN A DIFFERENT POSITION. (FOR EXAMPLE, IF THE MANUFACTURE RECOMMENDS 3 QUARTS OF FLUID, MAKE SURE THE DIFF HAS 3 QUARTS OF FLUID). CHECK YOUR SPECIFIC MANUAL FOR CORRECT AMOUNT OF FLUID.

MUST USE 18 INCH WHEELS OR LARGER ON THIS LIFT.



*6" 2006-08 Dodge 1500 4WD
FTS23021BK / FTS23008BK*

Parts List

FTS23021BK 6" Comp. Box 1		
Qty	Part #	Description
1	FTS44115D	Drv. Spindle
1	FTS44115P	Pass. Spindle
2	FT44066	Tie Rod End 17mm
1	FT44020	Diff Mount Front Pass.
1	FT44026	Diff Mount Rear Pass
1	FT44021	Diff Mount Driver Outer
1	FT44027	Diff Mount Driver Inner
1	FT44022	Diff Mount Driver Rear
2	FT44073	Lower Sway Bar Mount
2	FT44075	Sway Bar End Link
2	FT44133	Sway Bar Spacer
1	FT44134	Hdwr Sub-Assembly Kit
1	FT44077	Hardware Kit 1

FT44134 Hdwr Sub-Assembly Kit		
Qty	Part #	Description
1	FT44071	Drv. Brake Line Mount
1	FT44072	Pass Brake Line Mount
2	FTS98003	Heim Joint
4	FTS43	Mis-Alignment
1	FT1044	Bushing Kit
1	FT90084	Bushing Kit
6	12008007100	Zip Tie
4	10601501082	10MM-1.5 X 60MM Hex Bolt
2	37000005052	3/8" SAE Flat Washer
2	37000005252	3/8" Split Lock Washer
1	FTAS12	Sticker
1	FTAS16	Decal
1	FTREGCARD	Registration Card
2	FT23021i	Instruction Sheet

FTS23008BK 6" Comp. Box 2		
Qty	Part #	Description
1	FT44358BK	Frnt. Crossmember
1	FT44089BK	Rear Crossmember
1	FT44357BK	Skid Plate
1	FT44029	Front Drive Shaft Spacer
2	FT44074BK	Impact Tube
2	FT44068BK	Impact Tube Mounts
1	FT44122	Hdwr Sub-Assembly
1	FT44078	Hardware Kit 2
2	FT44056	Add-A-Leaf

FT44122 Hdwr Sub-Assembly Kit		
Qty	Part #	Description
2	CB-06X5	Center Pin Bolt
2	37240003952	Center Pin Nut
1	FT44069	Drv. Impact Mount Nut Tab
1	FT44070	Pass Impact Mount Nut Tab

FTS23009BK 6" Box 3 Shock Spacer Kit		
Qty	Part #	Description
1	FT44065BK	6" Shock Spacer Drv
1	FT44067BK	6" Shock Spacer Pass

"OR"

FTS23157 6" Box 3 Dirt Logic 2.5 Coil Over		
Qty	Part #	Description
2	FT825132	2.5 Coil Over



6" 2006-08 Dodge 1500 4WD
 FTS23021BK / FTS23008BK

Hardware List:

Hardware Kit FT44077		
Qty.	Description	Location
4	5/8"-11 x 5 1/2" Bolt	F & R Crossmember
4	5/8"-11 C-Lock Nut	
8	5/8" SAE Flat Washer	
4	1/2"-13 x 2 1/2" Bolt	Front Diff Brkt Drv.Frt
3	9/16"-12 x 2 1/4" Bolt	Front Diff Brkt Drv. Rr
4	1/2"-13 x 2 3/4" Bolt	Front Diff Brkt Pass.
8	1/2"-13 C-Lock Nut	Front Diff Brkt D & P
16	1/2" SAE Flat Washer	
3	9/16"-12 Lock Nut	Front Diff Brkt Drv. Rr
3	9/16" SAE Flat Washer	
6	7/16"-14 C-Lock Nut	Coilover Spacer
6	7/16" SAE Flat Washer	
4	12mmx1.75x45mm Bolt	Front Drive Shaft
4	12mm Flat Washers	
1	Thread-Locking Compound	

Hardware Kit FT44078		
Qty.	Description	Location
2	1/2"-13 x 2 3/4" Hex Cap Bolt	Sway Bar Links
2	1/2"-13 C-Lock Nut	
4	1/2" SAE Flat Washer	
2	3/4"-16 Jamb Nut	
2	1/2"-13 x 3" Button Head Bolt	
2	3/8"-16 C-Lock Nut	Sway Bar Brackets
2	3/8" SAE Flat Washer	
2	1/4"-20 x 3/4" Hex Cap Bolt	Front Brkt Line Drop
2	1/4"-20 C-Lock Nut	
4	1/4" SAE Flat Washer	
4	7/16"-14 x 3 1/2" Bolt	Impact Struts
4	7/16"-14 C-Lock Nut	
8	7/16" SAE Flat Washer	
4	7/16"-14 x 1 1/4"	Impact Strut Bracket
4	7/16" SAE Flat Washers	
4	7/16" Split Washer	
1	1/2"-13 x 2 3/4" Bolt	Differential Skid Plate
1	1/2"-13 x 1 1/4" Bolt	
1	1/2"-13 C-Lock Nut	
3	1/2" SAE Flat Washer	
1	1/2" Split Washer	
2	Adel Clamps	Front ABS
2	1/4"-20 x 3/4" Hex Cap Bolt	
2	1/4" SAE Flat Washer	

FRONT SUSPENSION INSTRUCTIONS:

1. Disconnect the negative terminal on the battery. With the vehicle on level ground set the emergency brake and block the rear tires. **If installing optional Coilover Shocks, take an accurate measurement of the front of the truck. This measurement will need to be taken from the center of the front wheel hub to the centermost part of the wheel well opening. This measurement will be needed to correctly set the height for the new Coil Over shocks. DO NOT exceed the 6" over stock height. Record your measurements below.**

Right _____ Left _____

2. Jack up the front end of the truck and support the frame rails with jack stands. **NEVER WORK UNDER AN UNSUPPORTED VEHICLE!** Remove the front tires.
3. Remove the factory transfer case skid plate and discard.
4. Disconnect the front drive shaft from the differential and discard the hardware. (do not allow to hang freely)
5. Locate the sway bar end links and disconnect them from the lower control arms and the sway bar. Discard the end links and hardware. Leave the factory sway bar on the truck attached to the frame mounts.
6. Working from the driver side of the vehicle, disconnect the tie rod end from the steering knuckle by striking the knuckle to dislodge the tie rod end. Do not remove the factory Jamb Nut from the inner tie rod. Discard the tie rod as a new Fabtech tie rod end will be installed later. SEE PHOTO BELOW.



7. Remove the brake caliper and place it next to the frame. Do not overstretch the brake hose when doing so. **DO NOT LET THE BRAKE CALIPER HANG FROM THE BRAKE HOSE.** Retain the hardware for reinstallation.

8. Remove the axle nut from the center of the hub and save.
9. Remove the upper and lower ball joint nuts and save. Using a large hammer strike the spindle to dislodge the ball joints from the spindle. **USE CARE NOT TO DAMAGE THE THREADS ON THE BALL JOINTS.** Remove the spindle from the truck.
10. Remove the bolts attaching the hub bearing to the spindle and save. Remove hub assembly along with the ABS sensor wire and dust shield from the spindle as one and save. **NOTE; Do not disconnect the ABS sensor from the hub at anytime. Note position of the hub in the spindle for later re-installation.** Discard the spindle.
11. Remove the three upper strut assembly bolts from the truck and save. Remove the lower shock bolt and save. Remove the strut assembly from the truck and save. **The factory shock assembly will be reused if you are installing the 6" Basic System. If you are installing the 6" Performance System you can discard the factory shock assembly and hardware.**
12. Remove the factory lower control arm bolts / alignment cams and save. Remove the lower control arm and save.
13. Remove the C.V. half shaft from the differential. This can be done by using a rubber mallet and striking the backside of the inner C.V. joint housing. Save the half shaft. **NOTE: The differential may leak some gear oil.**
14. Repeat steps five through twelve on the passenger side of the truck.
15. Remove the factory rear crossmember from the truck and discard the crossmember and hardware.
16. Support the differential with a floor jack or transmission jack, remove the differential from the truck. Save the hardware from the driver rear differential mount and discard the rest.
17. Locate the driver side rear lower control arm mount where the factory rear crossmember was previously removed. **As shown in the picture below cut a 1" section from the side of the frame and 1/2" from the bottom of the frame.** SEE PHOTOS ON NEXT PAGE.

DUE TO VARIANCES IN EACH TRUCK, ADDITIONAL CUTTING / GRINDING MAY BE REQUIRED FOR PROPER FITMENT OF THE CROSSMEMBERS AND DIFFERENTIAL. USE THESE MEASUREMENTS AS A STARTING POINT AND CLEARANCE THE FRAME POCKETS AS

**NEEDED FOR PROPER FITMENT OF THE
CROSSMEMBERS & DIFFERENTIAL**

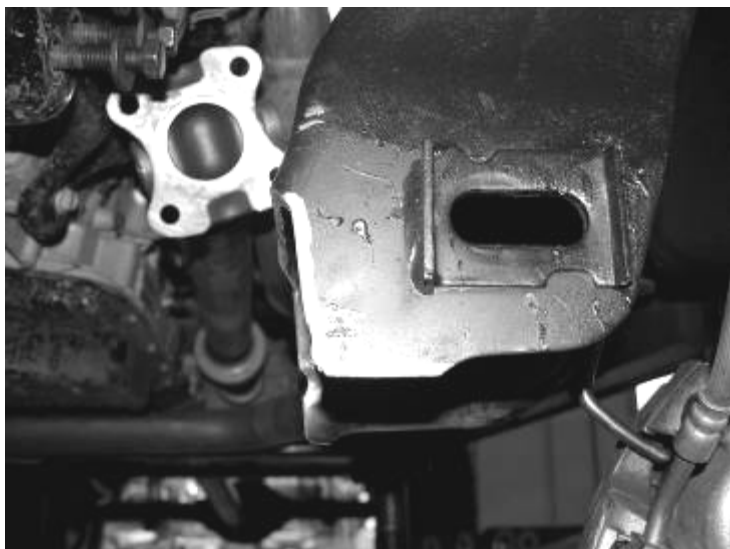

View shown looking from front to rear (Driver Side)

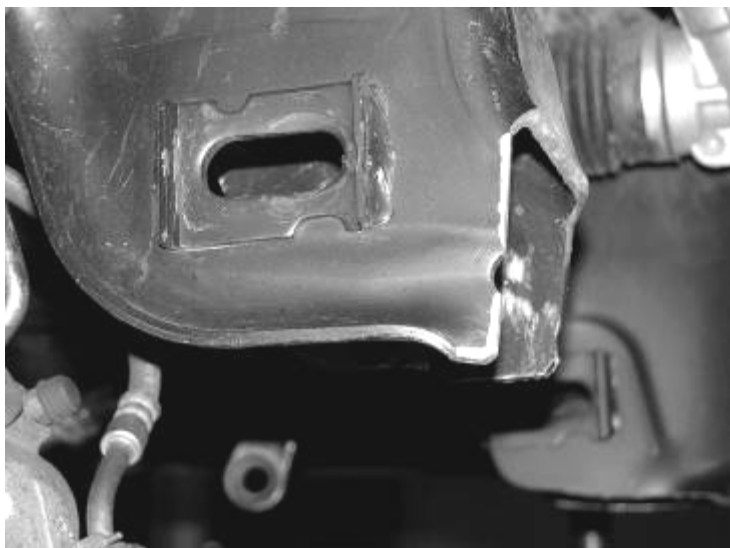

View shown looking from rear to front (Driver side)

18. Locate the Passenger side rear lower control arm mount where the factory rear crossmember was previously removed. As shown in the picture below cut a 1" section from the side of the frame and 1/2" from the bottom of the frame. SEE PHOTOS BELOW.

**DUE TO VARIANCES IN EACH TRUCK,
ADDITIONAL CUTTING / GRINDING MAY BE
REQUIRED FOR PROPER FITMENT OF THE
CROSSMEMBERS. USE THESE MEASUREMENTS
AS A STARTING POINT AND CLEARANCE THE
FRAME POCKETS AS NEEDED FOR PROPER
FITMENT OF THE CROSSMEMBERS**



View shown looking from front to rear (Pass Side)



View shown looking from rear to front (Pass Side)

19. Locate the factory front lower control arm pockets. Grind 1/4" section from both pockets as shown in the photo. SEE PHOTOS BELOW.

**DUE TO VARIANCES IN EACH TRUCK,
ADDITIONAL CUTTING / GRINDING MAY BE
REQUIRED FOR PROPER FITMENT OF THE
CROSSMEMBERS. USE THESE MEASUREMENTS
AS A STARTING POINT AND CLEARANCE THE
FRAME POCKETS AS NEEDED FOR PROPER
FITMENT OF THE CROSSMEMBERS**

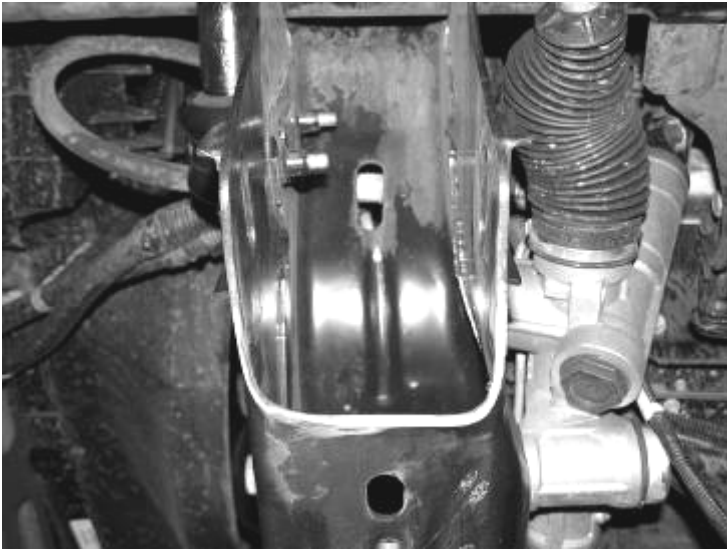

Drivers Side (Front Crossmember)

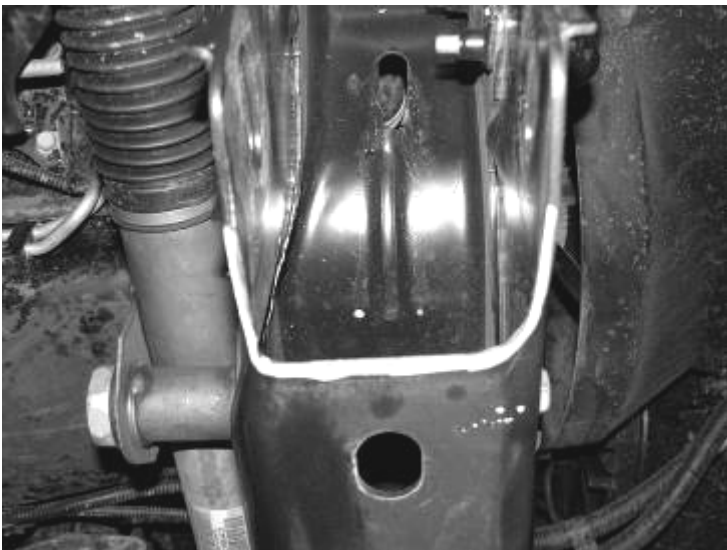

Passenger Side (Front Crossmember)

20. Locate FT44020 and FT44026 passenger side diff mounts. Using the supplied $\frac{1}{2}$ " X $2\frac{3}{4}$ " hardware attach the brackets to the differential as shown in the diagram. Leave loose at this time. SEE THE DIAGRAM ON THE LAST PAGE AND PHOTO BELOW.



21. Locate FT44021 and FT44027 Driver front diff mounts. Using the supplied $\frac{1}{2}$ " X $2\frac{1}{2}$ " hardware attach the brackets to the differential as shown in the diagram. Leave loose at this time. SEE THE DIAGRAM ON THE LAST PAGE AND PHOTO BELOW.

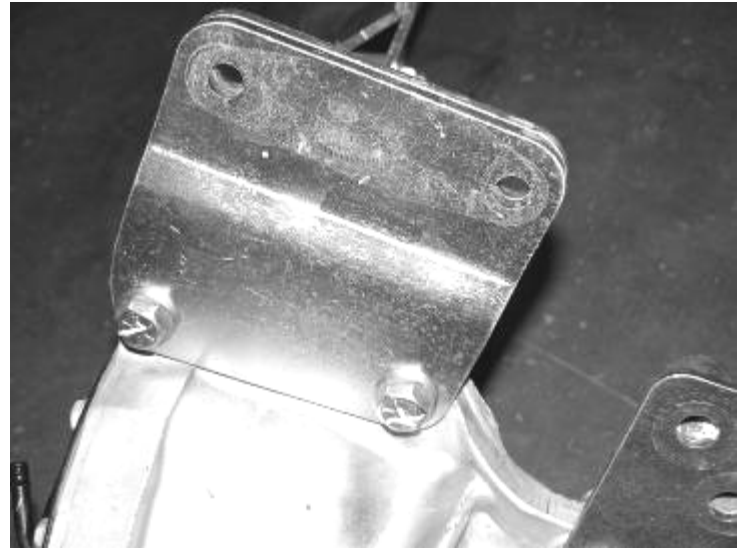

22. Locate FT44022 Driver rear diff mount. Using the original hardware attach the bracket to the original frame mount. Leave loose at this time. SEE THE DIAGRAM ON THE LAST PAGE.

23. Install the differential back into the truck attaching the new Fabtech drop brackets to the frame mounts. Use the supplied $\frac{1}{2}$ " x $2\frac{3}{4}$ " bolts, nuts, and washer on the passenger side bracket and use the supplied $\frac{9}{16}$ " X $2\frac{1}{4}$ " bolt, nuts, and washer on the driver rear brackets. **Do not** mount the Driver front diff mount at this time. LEAVE ALL HARDWARE LOOSE AT THIS TIME.

24. Locate FT44358BK front crossmember and install it into the front lower control arm pockets using the supplied $\frac{5}{8}$ " x $5\frac{1}{2}$ " bolts, nuts, and washers. Leave loose at this time. SEE PHOTO BELOW.



25. Locate FT44089BK rear crossmember and install it into the frame pockets using the 5/8" x 5 1/2" bolts, nuts, and washers. Leave loose at this time. SEE PHOTO BELOW.



26. Install the supplied 1/2" x 2 1/2" bolts, nuts, and washers on the driver side front diff bracket. Torque all differential hardware to 127 ft lbs. SEE PHOTO BELOW



27. Working from the driver side of the truck, install the factory lower control arm to the Fabtech crossmembers using the original alignment cam bolts. Leave loose at this time. SEE PHOTO IN NEXT COLUMN.



28. Install the C.V. half shaft back onto the differential by pushing the half shaft onto the splines until the snap ring locks. SEE PHOTO BELOW

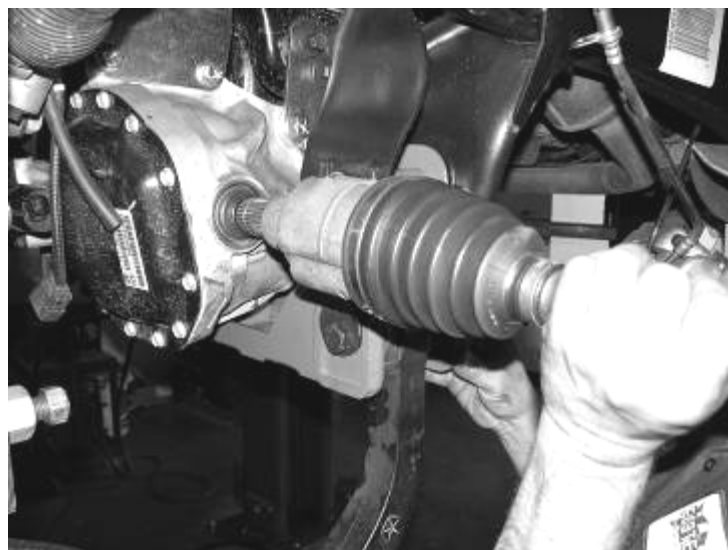

FOLLOW STEPS TWENTY-NINE THROUGH THIRTY FOR BASIC KIT ONLY.

IF INSTALLING THE PERFORMANCE 2.5 DIRT LOGIC COIL OVER KIT, INSTALL THE COILOVER SO IT IS OFFSET AWAY FROM THE AXLE SHAFT.

29. Locate the previously removed shock assembly and attach FT44065BK (driver side) and FT44067BK (passenger side) spacer to the top of the stock assembly using the stock hardware. Use a small amount of the supplied thread locking compound on the supplied strut to spacer hardware. **You will need to mount the spacer so that it aligns properly with the coilover.** SEE PHOTOS ON NEXT PAGE.



30. Install the complete shock assembly into the truck attaching the three upper bolts first using the supplied 3/8" C-lock and flat washers, leave loose. Torque upper hardware to 52 ft. lbs. SEE PHOTO BELOW



RESUME INSTALL ON ALL KITS.

31. Locate FT44115D (driver) Steering Knuckle. Attach the previously removed hub bearing and dust shield to the knuckle in the same position as when removed using the original hardware and a small amount of the supplied thread locking compound on each bolt. Torque to 95 ft. lbs. Use the supplied adel clamp and 1/4" x 3/4" hardware a small amount of thread locking compound and attach the A.B.S. line to the front of the knuckle. SEE PHOTOS BELOW.



Photo shows Adel clamp attaching ABS Line to knuckle

32. Attach the steering knuckle to the lower ball joint first, and then slide the C.V. shaft end through the hub bearing, followed by the upper ball joint to the steering knuckle. Torque the lower ball joint nut to 85 ft lbs and the upper ball joint nut to 50 ft lbs. Using the original C.V. axle nut attach the C.V. axle to the hub assembly. Torque to 100 ft lbs. Then attach the lower shock mount to the original mount on the lower control arm using the original hardware and torque to 90 ft. lbs. SEE PHOTOS ON NEXT PAGE.



33. Repeat steps Twenty-Seven through Thirty-Two on Passenger side of truck.
34. Locate FT44357 skid plate and attach to the front crossmember using the supplied $\frac{1}{2}$ " X $2 \frac{3}{4}$ " bolt, nut, and washer, and to the rear crossmember using the supplied $\frac{1}{2}$ " x $1 \frac{1}{4}$ " bolt and flat and split washer. SEE PHOTO IN NEXT COLUMN.



35. Torque the Fabtech crossmember bolts to 100 ft lbs and control arm pivot bolts / Alignment Cams to 110 ft. lbs. Set the cams in the middle of their adjustment.
36. Locate the factory brake line in the coilover tower. Carefully cut the tower to remove the brake line. Remove the bracket from the frame saving the hardware. Carefully pull the brake line down from the frame approximately 4" (**use care to not damage the hard line**) Locate FT44071 Driver Brake Line Drop Mount Bracket and attach in original brake line mounting position. Locate the supplied $\frac{1}{4}$ "x $\frac{3}{4}$ " hardware and attach the factory brake line bracket to the new drop bracket. SEE PHOTO BELOW

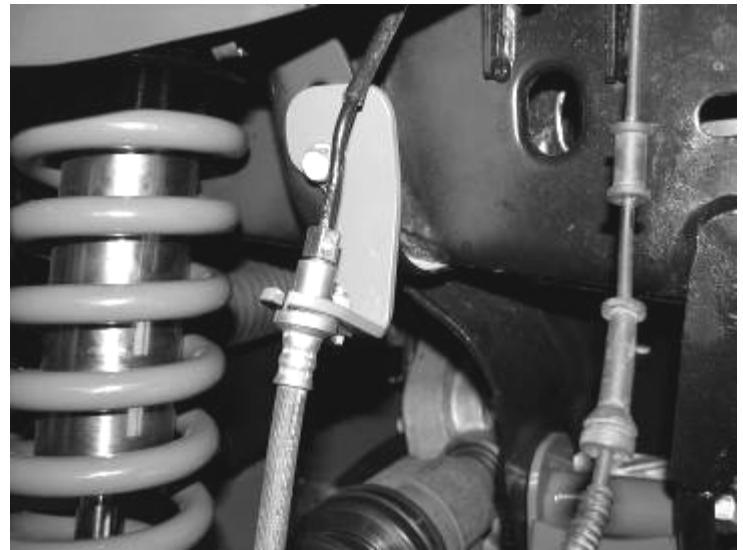

37. Working from the drivers side, install the factory brake rotor and caliper. Use a small amount of the supplied thread lock compound on the caliper bolts and torque to 145 ft. lbs.
38. Locate the ABS plug on the inside of the fender well liner and remove the plastic clip holding it to the liner (**use care not to damage connector**). Route the ABS wire up from the knuckle parallel with brake lines and attach to the brake lines with the supplied zip ties. SEE PHOTOS ON NEXT PAGE.

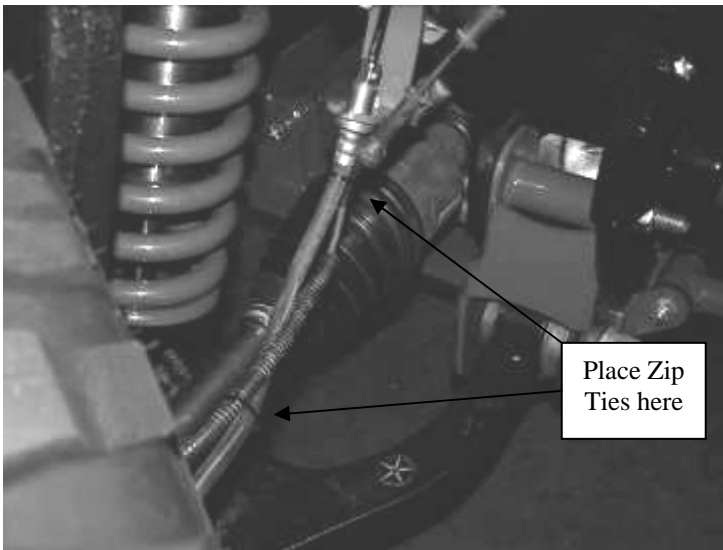
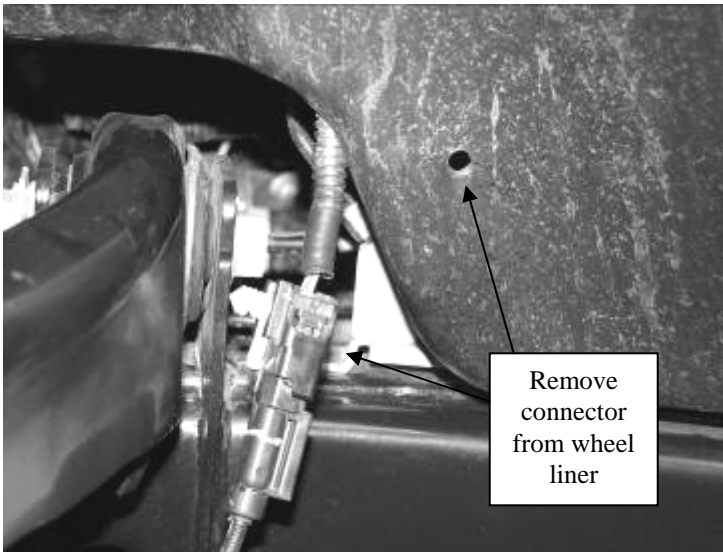

39. Using a measuring tape, measure the amount of threads showing from the tie rod end in. **RECORD THIS MEASUREMENT.** Loosen the jam nut holding the outer tie rod end on and remove the out tie rod end and discard. Leave the jam nut on the inner tie rod end.
40. Locate the inner tie rod ends. Mark a 1/2" in from the end of the tie rod. Using a die grinder with a cutoff wheel, cut a 1/2" off of the end of the inner tie rod. Next using a die grinder with a sanding disc, clean up the threads on the inner tie rod so that the outer tie rod threads on without any binding of the threads. SEE PHOTOS IN NEXT COLUMN.

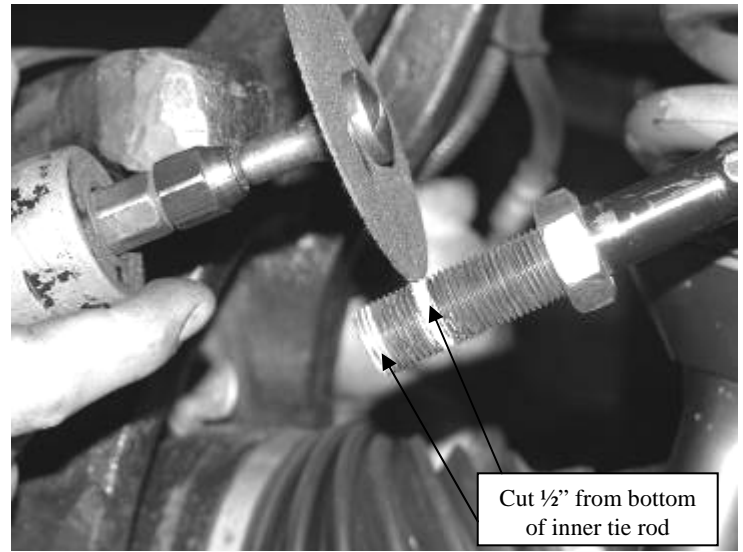

41. Locate FT44066 tie rod end and thread it onto the factory inner tie rod end to the measurement recorded earlier. **Note: This is just a starting point, the toe adjustment will need to be set during the final alignment.** Tighten the jam nut up to the tie rod end. Attach the tie rod end to the spindle using the supplied 14mm nut. Torque to 85 ft lbs.
42. Repeat steps thirty-six through thirty-nine on the passenger side of the truck.
43. Locate FT44029 front drive shaft spacer. Using the supplied thread-locking compound, 12mm bolts, and washer, attach the spacer and drive shaft to the front differential. Torque to 135 ft. lbs. SEE PHOTO ON NEXT PAGE.



44. Locate FT44073 Lower Sway Bar Mounts and supplied 3/8" C-lock nuts and flat washers. Attach the mounts to the lower A-Arm in the factory sway bar location. Leave loose at this time.
45. Loosen the Four bolts holding the Sway Bar to the factory crossmember, Remove the Two bolts from the driver side and discard. Locate and insert the FT44133 Sway Bar Spacer with the supplied 10MM bolts and flat and lock washers, and leave loose. Repeat on the passenger side leaving hardware loose. SEE PHOTOS BELOW AND IN NEXT COLUMN.

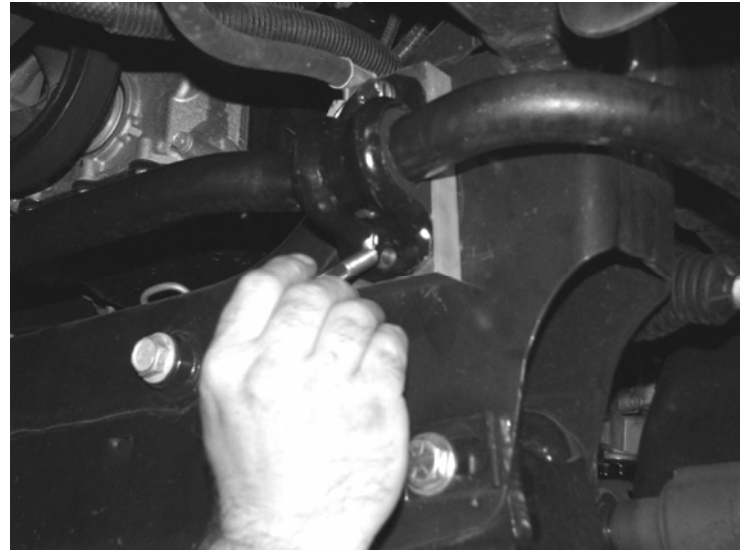

46. Locate both FT44075 Billet Sway Bar End Links and both of the supplied FTS98003 heim joints along with the supplied jam nuts. Thread the jam nuts all the way onto the heim joints, then thread the heim joints into the large end of the end links. Leave the jam nuts loose at this time. Locate the supplied 1/2" button head bolts and the FT90084 sway bar bushings along with the cup washers. Attach the bushing end of the sway bar end links to the factory sway bar, leave loose at this time. Attach the other end of the link using the supplied FTS43 mis-alignments and supplied 1/2" x 2 3/4" hardware to the new mount on the lower arm. Torque upper and lower hardware to 60 ft. lbs. **At times this may be easier to attach when the truck is completed and on the ground.** SEE PHOTOS BELOW AND ON NEXT PAGE.



Driver Side Shown

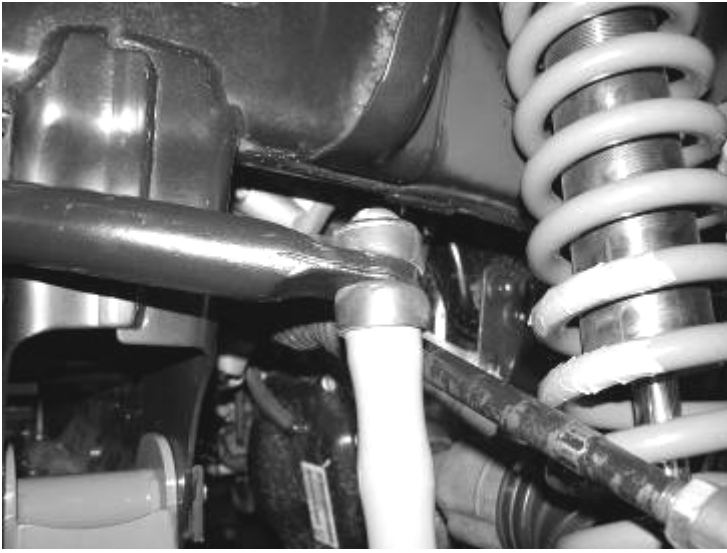

Driver Side Shown.

47. Locate the FT44074 Impact Strut Tubes and install two bushings from the supplied FT1044 bushing kit into each end of the tubes.
48. Using the supplied 7/16" x 3 1/2" bolts, nuts and washers attach the impact tubes to the rear crossmember tabs. Leave bolts loose at this time.
49. Attach FT44068 impact tube mounts (**the flat side of the mount faces outward for alignment with the nut tabs**) to the free end of the impact tubes using the supplied 7/16" x 3 1/2" bolts, nuts, and hardware. Leave loose at this time.
50. Swing the strut tube, with the rear mounting bracket attached, up to meet the transmission crossmember. With a center punch mark the holes and drill out to 7/16" (**only use the inner and front holes in the mount, the center hole will not be used**). Using the supplied 7/16" x 1 1/4" bolts and washers along with the supplied FT44069 (driver side) and FT44070 (pass side) nut tabs attach the bracket to the frame. Torque the rear mount bracket to 83 ft lbs, and the 7/16" impact tube bolts to 45 ft lbs. **SEE PHOTOS BELOW AND IN NEXT COLUMN.**



Photo Shown Installing the Nut Tab Into The Frame.

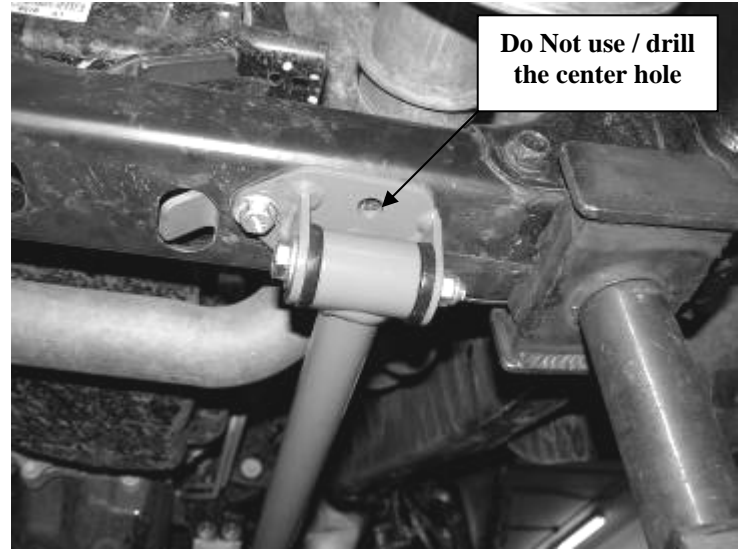

Note position of the Impact Tube Mount.

51. Install front tires and wheels. Torque lug nuts to wheel manufacturers specifications

Double Check That All Nuts And Bolts Are Now Tight Before Proceeding To The Rear.

REAR SUSPENSION INSTRUCTIONS:

52. Jack up the rear end of the vehicle and support the frame rails with jack stands. Block the front wheels so the truck will not roll. Release the parking brake at this time. While supporting the rear differential remove the rear shocks, u-bolts, and lower axle down. Save the u-bolts and hardware, discard the shocks. **USE CARE NOT TO OVER EXTEND THE BRAKE LINES.**
53. Separate the springs and install the provided FT44056 add a leaf with the new center bolt in a pyramid pattern smallest on the bottom graduating to the longest on top. The factory flat overload leaf should remain on the bottom of the pack. (**Make sure that the Factory Locating Dowel Pin is aligned throughout the entire leaf pack when installing the new center pin**) Clamp the spring and tighten the center bolt as not to leave a gap between the springs. Cut the thread of the bolt smooth with the nut. The nut should be on the top of the leaf spring pack.
54. Using the factory U-bolts, nuts, and washers align the axle and springs and torque the U-Bolts to 90lbs.
55. Install the new Fabtech shocks (not included with the kit) and Torque to 65 lbs using factory hardware on both upper and lower mounts.
56. Recheck all bolts for proper torque. Recheck the front and rear brake hoses and ABS lines for proper clearances.

57. Install tires and wheels and torque lug nuts to wheel manufacturers specifications. Turn front tires left to right and check for appropriate tire clearance. Note-Some oversized tires may require trimming of the bumper and valance.

58. Check the front-end alignment and set to the factory specifications.

59. Check front differential fluid level due to CV Shaft removal and refill to manufactures recommended level with recommended fluid type (see owners manual).

60. Adjust the front headlights to the proper angle.

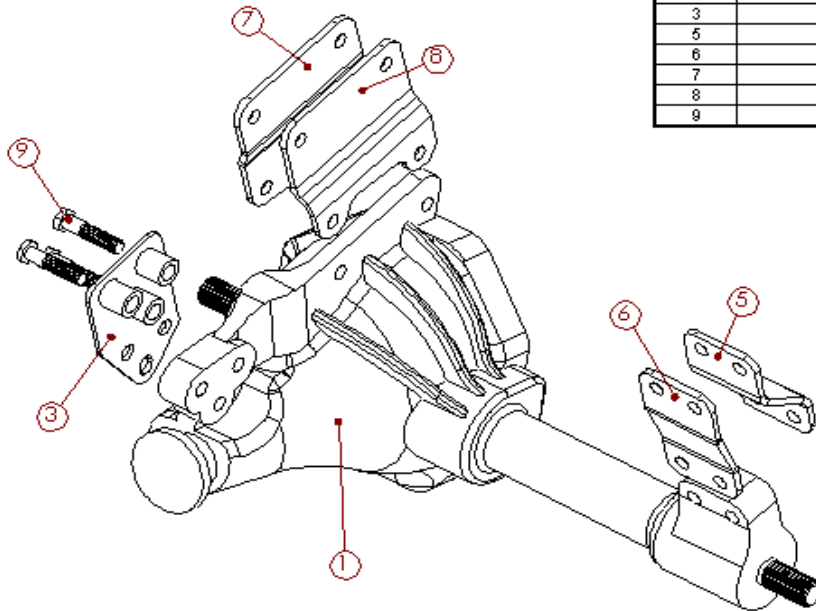

ITEM#	DESCRIPTION
1	FRONT DIFFERENTIAL
3	FT44022
5	FT44020
6	FT44026
7	FT44021
8	FT44027
9	FACTORY BOLTS

S.A.E. Bolt Torque Specification Chart

Grade 5

Grade 8

Metric



Standard

Metric

	Grade 5	Grade 8		Grade 8.8	Grade 10.9
SIZE	ft. lbs.	ft. lbs.	SIZE	ft. lbs.	ft. lbs.
1/4"	10	14	M-6	7	12
5/16"	21	29	M-8	17	29
3/8"	37	52	M-10	35	58
7/16"	59	83	M-12	65	100
1/2"	90	127	M-14	100	160
9/16"	129	184	M-16	150	240
5/8"	179	254	M-18	200	300
3/4"	317	450	M-20	300	400

RETORQUE ALL NUTS, BOLTS AND LUGS AFTER 50 MILES AND PERIODICALLY THEREAFTER.

For technical assistance call: 909-597-7800

Product Warranty and Warnings-

Fabtech provides a Limited Lifetime Warranty to the original retail purchaser who owns the vehicle, on which the product was originally installed, for defects in workmanship and materials.

The Limited Lifetime Warranty excludes the following Fabtech items; bushings, bump stops, ball joints, tie rod ends, limiting straps, cross shafts, heim joints. These parts are subject to wear and are not considered defective when worn. They are warranted for 60 days from the date of purchase for defects in workmanship.

Take apart shocks are considered a serviceable shock with a one year warranty on leakage only. Service seal kits are available separately for future maintenance. All other shocks are covered under our Limited Lifetime Warranty.

Fabtech does not warrant any product for finish, alterations, modifications and/or installation contrary to Fabtech's instructions. Alterations to the finish of the parts including but not limited to painting, powdercoating, plating and/or welding will void all warranties. Some finish damage may occur to parts during shipping which is considered normal and is not covered under warranty.

Fabtech products are not designed nor intended to be installed on vehicles used in race applications or for racing purposes or for similar activities. (A "RACE" is defined as any contest between two or more vehicles, or any contest of one or more vehicle against the clock, whether or not such contest is for a prize). This warranty does not include coverage for police or taxi vehicles, race vehicles, or vehicles used for government or commercial purposes. Also excluded from this warranty are sales outside of the United States of America.

Installation of most suspension products will raise the center of gravity of the vehicle and will cause the vehicle to handle differently than stock. It may increase the vehicle's susceptibility to a rollover, on road and off road, at all speeds. Extreme care should be taken to operate the vehicle safely at all times to prevent rollover or loss of control resulting in serious injury or death. Fabtech front end Desert Guards may impair the deployment or operation of vehicles equipped with supplemental restraining systems/air bag systems and should not be installed if the vehicle is equipped as so.

Fabtech makes every effort to ensure suspension product compatibility with all vehicles listed in the catalog, but due to unknown auto manufacturers production changes and/or inconsistencies by the auto manufacturer, Fabtech cannot be responsible for 100% compatibility, including the fitment of tire and wheel sizes listed. The Tire and Wheel sizes listed in Fabtech's catalog are only a guideline for street driving with noted fender trimming. Fabtech is not responsible for damages to the vehicle's body or tires.

Fabtech's obligation under this warranty is limited to the repair or replacement, at Fabtech option, of the defective product only. All costs of removal, installation or re-installation, freight charges, incidental or consequential damages are expressly excluded from this warranty. Fabtech is not responsible for damages and/or warranty of other vehicle parts related or non related to the installed Fabtech product. This warranty is expressly in lieu of all other warranties expressed or implied. This warranty shall not apply to any product that has been subject to accident, negligence, alteration, abuse or misuse as determined by Fabtech.

Fabtech suspension components must be installed as a complete system including shocks as shown in our current catalog. All warranties will become void if Fabtech parts are combined and/or substituted with other aftermarket suspension products. Combination and/or substitution of other aftermarket suspension parts may cause premature wear and/or product failure resulting in an accident causing injury or death. Fabtech does not warrant products not manufactured by Fabtech.

Installation of Fabtech product may void the vehicles factory warranty; it is the consumer's responsibility to check with their local vehicle's dealer for warranty disposition before the installation of the product.

It is the responsibility of the distributor and/or the retailer to review all warranties and warnings of Fabtech products with the consumer prior to purchase.

Fabtech reserves the right to supercede, discontinue, change the design, finish, part number and, or application of parts when deemed necessary without written notice. Fabtech is not responsible for misprints or typographical errors within the catalog or price sheet.