



Installation Instructions



*6" Performance Suspension System
1995.5-2004 Toyota Tacoma 4wd & 2wd Pre-Runner*

Fabtech Motorsports 4331 Eucalyptus Ave. Chino, CA 91710
Tech Line 909-597-7800 Fax 909-597-7185 Web www.fabtechmotorsports.com



6" 1995.5-2004 Toyota 4wd & 2wd Pre-Runner
PARTS LIST

	FTS26000	BOX 1 "ALL MODELS"
Qty.	Part #	Description
2	FT70001	Front Strut
1	FT70004	Diff Drop Bracket (Pass.)
1	FT70005	Diff Drop Bracket (Drv)
1	FT70006BK	Skid Plate (black only)
2	FT70008	Sway Bar Brackets
1	FT70155	Hardware
1	FT70137	Hdwr Sub-Assembly
1	FTS70007D	Knuckle Complete Drv.
1	FTS70007P	Knuckle Complete Pass

	FT70125	Hdwr Sub-Assembly Kit
Qty	Part #	Description
1	FT70014	Rear Brake Hose Extension
1	FT70015	Rear Brake Hard Line Extension
1	FT70016	Proportioning Valve Extension
1	FT70032	Rear Brake Line Axel Tab
1	FT70020	Rack Spacer (DRV)
1	FT1044	Bushing Kit
1	FT90086	Bushing Kit
1	FT916H	U-Bolt Hardware
2	CB-06X5	Center Bolt
2	37240003952	Center Bolt Nut

	FT70137	Hdwr Sub-Assembly Kit
Qty	Part #	Description
2	FT26000i	Instruction Sheets
2	FT70022	ABS & Brake Hose Bracket
2	FT70024	ABS Cap
2	FT70027	Outer Wheel Bearing Seal
2	FT70030	Wheel Bearing Lock Nut
2	FT70045	Hub Bearing Thrust Washer
1	FTS12	Decal
1	FTAS16	Driver Warning
1	FTREGCARD	Registration Card

	FTS26003	BOX 2 "4CYL ONLY"
Qty.	Part #	Description
4	FT1500U	U Bolts
2	FT205	Add a Leaf
1	FT70003BK	Rear Crossmember
1	FT70010	Steering Shaft Extension
2	FT70011BK	Impact Strut
2	FT70012BK	Impact Strut Rear Mount
1	FT70018	Hardware Kit
1	FT70019	Rack Spacer Pass (alum. Block)
1	FT70036BK	Front Crossmember 4 CYL
1	FT70128	Hdwr Sub-Assembly
2	FTBK3	3" Blocks

	FTS26001	BOX 2 "V6 ONLY"
Qty.	Part #	Description
1	FT70002BK	Front Crossmember
1	FT70003BK	Rear Crossmember
2	FT70011BK	Impact Strut
2	FT70012BK	Impact Strut Rear Mount
1	FT70019	Rack Spacer (Pass)
1	FT70010	Steering Shaft Extension
1	FT70018	Hardware Kit
2	FTBK3	3" Blocks
4	FT1500U	U-Bolts
1	FT70125	Hdwr Sub-Assembly
2	FT205	Add a Leaf

	FT70128	Hdwr Sub-Assembly Kit
Qty	Part #	Description
2	CB-06X5	Center Bolt
1	FT1044	Bushing Kit
1	FT70014	Rear Brake Hose Extension
1	FT70015	Rr Brake Hard Line Extension
1	FT70016	Proportioning Valve Extension
1	FT70020	Rack Spacer Drv (Sleeve)
1	FT70032	Rear Brake Line Axel Tab
1	FT70037	P/S Pressure Line
1	FT70038	P/S Return Line
1	FT90040	Small Hose Clamp
1	FT90086	Bushing Kit
1	FT916H	U Bolt Hardware
2	37240003952	Center Bolt Nut



**6" 1995.5-2004 Toyota 4wd & 2wd Pre-Runner
FTS26000 & BK / FTS26001 & BK**

HARDWARE LIST:

FT70155 Hardware Kit	
1	5/8"-11x5" Bolt
1	5/8"-11 Nyloc Nut
1	5/8" SAE Washer
1	1/2" x 5" Bolt
1	1/2" C-Lock Nut
2	1/2" SAE Flat Washer
3	5/16" X 1/2" Self Taper Bolt
4	3/8" x 5" Bolt
2	3/8" x 3" Bolt
6	3/8" Nyloc Nut
12	3/8" SAE Flat Washer
4	7/16" x 3 1/2" Bolt
4	7/16" Nyloc Nut
8	7/16" SAE Washer
3	Adel Clamp
1	Lock Tight

FT70018 Hardware Kit	
4	3/4" x 4 1/2" Bolt
4	3/4" C-Lock Nut
8	3/4" SAE Flat Washer
2	1/2" X 5 1/2" Bolt
1	1/2" X 3" Bolt
1	1/2" x 1 1/2" Bolt
2	1/2" Nyloc Nut
2	1/2" C-lock Nut
8	1/2" SAE Flat Washer
2	9/16" X 3" Bolt
2	9/16" C-Lock Bolt
4	9/16" SAE Flat Washer
7	5/16" x 1 1/4" Bolt
1	5/16" X 1 Bolt
8	5/16 Nyloc Nut
16	5/16" SAE flat Washer
1	1/4" x 1" Bolt
1	1/4" Nyloc Nut
2	1/4" SAE Flat Washer
4	Cotter Pin 1/8" x 2"

FT70155 (cont)	
2	6mm -1.0 x 20mm
2	6mm Split Washer
2	6mm Flat Washer
1	1/2"-13 x 2 3/4" Bolt
1	1/2"-13 X 5" Bolt
3	1/2"-13 Nyloc Nut
5	1/2" SAE Flat Washer
4	1/4"-20 X 3/4"
4	1/4"-20 Nyloc Nut
8	1/4" SAE Flat Washer
2	5/16"-18 x 2" Bolt
2	5/16"-18 Nyloc Nut
4	5/16" SAE Flat Washer
3ft	3/4" split wire loom 3 foot section
2	Adel Clamps

TOOL LIST: (NOT INCLUDED)

- **FLOOR JACK & JACK STANDS**
- **ASSORTED METRIC AND S.A.E SOCKETS, & WRENCHES**
- **LARGE C CLAMP OR C CLAMP VISE GRIPS**
- **DIE GRINDER WITH CUTOFF WHEEL OR SAWZALL**
- **TORQUE WRENCH**
- **HYDRAULIC PRESS**
- **COIL SPRING COMPRESSOR**
- **TOYOTA TOOL PART # SST 09318-12010U – For Manual Hub Truck installation only**

NOTE: THIS KIT WILL NOT WORK WITH AN EXISTING BODY LIFT.

CHECK ALL PARTS INCLUDED IN THIS KIT TO THE PARTS LIST ABOVE BEFORE BEGINNING INSTALLATION OF THIS KIT. IF ANY PARTS ARE MISSING, CONTACT FABTECH AT 909-597-7800

THIS SYSTEM HAS BEEN DESIGNED TO USE 35/1250R15 TIRES AND 15 X 8 WHEELS W/ 3-3/4" BACKSPACING WHEELS OR 315/75/R16 TIRES AND 16X8 WHEELS W/ 4" BACKSPACING

IF YOUR VEHICLE CAME FACTORY EQUIPPED WITH 16" WHEELS, THEN FABTECH RECOMMENDS RETAINING THE ORIGINAL 16" DIAMETER WHEEL.

THE INSTALLATION OF THIS SUSPENSION SYSTEM SHOULD BE PERFORMED BY TWO PROFESSIONAL MECHANICS.

DO NOT ALTER THE FINISH OF THESE COMPONENTS, EXAMPLE- CHROMING, ZINC PLATING OR PAINTING. CHANGING THE FINISH CAN CAUSE STRUCTURAL FATIGUE OF COMPONENTS.



*6" 1995.5-2004 Toyota 4wd & 2wd Pre-Runner
FTS26000 & BK / FTS26001 & BK*

VERIFY DIFFERENTIAL FLUID IS AT MANUFACTURES RECOMMENED LEVEL PRIOR TO KIT INSTALLATION. INSTALLATION OF THE KIT WILL RE-POSITION THE DIFFERENTIAL AND THE FILL PLUG HOLE MAY BE IN A DIFFERENT POSITION. (FOR EXAMPLE, IF THE MANUFACTURE RECCOMENDS 3 QUARTS OF FLUID, MAKE SURE THE DIFF HAS 3 QUARTS OF FLUID). CHECK YOUR SPECIFIC MANUAL FOR CORRECT AMOUNT OF FLUID.

SUSPENSION SYSTEM MUST BE INSTALLED WITH FABTECH SHOCKS

ON 1995-1996 MODELS CONTACT FABTECH AT 909-597-7800 FOR SWAY BAR END LINK MODIFICATION.

ON 2WD PRE-RUNNER MODELS YOU WILL NEED TO PURCHASE PART # 43442-35050 (QTY. 2) INNER BEARING CAP FROM YOUR LOCAL TOYOTA DEALER TO INSTALL ON THE BACK SIDE OF THE NEW STEERING KNUCKLE.

READ ALL INSTRUCTIONS THOROUGHLY FROM START TO FINISH BEFORE BEGINNING INSTALLATION! IF THESE INSTRUCTIONS ARE NOT PROPERLY FOLLOWED, SEVERE FRAME, DRIVELINE AND / OR SUSPENSION DAMAGE MAY RESULT.

NOTE- PRIOR TO THE INSTALLATION OF THIS SUSPENSION SYSTEM A FRONT END ALIGNMENT MUST BE PERFORMED AND RECORDED. DO NOT INSTALL THIS SYSTEM IF THE VEHICLE ALIGNMENT IS NOT WITHIN FACTORY SPECIFICATIONS. CHECK FOR FRAME AND SUSPENSION DAMAGE PRIOR TO INSTALLATION. THIS SUSPENSION SYSTEM DOES NOT REQUIRE WELDING FOR INSTALLATION. DO NOT WELD ANY OF THESE COMPONENTS.

INSTALLATION OF THIS SYSTEM REQUIRES EXTENSIVE HYDRAULIC PRESS WORK TO BE PERFORMED BY A PROFESSIONAL SHOP. FABTECH IS NOT RESPONSIBLE FOR DAMAGE TO BEARINGS SUPPLIED IN THIS SYSTEM DUE TO IMPROPER INSTALLATION OF BEARINGS.

FRONT SUSPENSION INSTRUCTIONS:

1. Disconnect the negative terminal on the battery. With the vehicle on level ground set the emergency brake and block the rear tires. Disconnect the battery. Jack up the front end of the truck and support the frame rails with jack stands.
NEVER WORK UNDER AN UNSUPPORTED VEHICLE! Remove the front tires.
2. Working from both sides of the truck, locate and remove the two factory skid plates. These will not be reinstalled on the truck.
3. Remove the sway bar from the truck and save along with all hardware.
4. Remove the nut from the tie rod ends. Disconnect the tie rod ends from the steering knuckle by striking the knuckle with a large hammer to dislodge the tie rod end. **Use care as to not hit the threads on the tie rod end with the hammer as you will damage them.**
5. Remove the brake caliper from the steering knuckle and place above the upper control arm, **do not allow the brake caliper to hang from brake line.** Trucks equipped with ABS brakes, unplug the ABS line and disconnect from steering knuckle.
6. Remove the brake rotor, axle nut dust cap, and axle nut from the hub assembly, save all hardware.
7. Loosen the upper ball joint nut. Disconnect the upper ball joint from the upper control arm by striking the upper arm with a large hammer next to the ball joint to dislodge the ball joint. **Use care not to hit the ball joint when removing.**

Remove and save factory nut. SEE PHOTO ON NEXT PAGE.



8. Remove the 4 bolts connecting the lower ball joint assembly to the knuckle. Save the bolts as you will reuse them. SEE PHOTO BELOW. Remove spindle assembly from truck.



9. Remove the shock assembly from truck as one complete unit, save hardware. Set aside as you will reuse the stock coil spring and isolator.
10. Remove factory steering coupler from the steering shaft. Save Clinch bolt and discard factory coupler and coupler hardware.
11. Remove the Rack and Pinion assembly from the factory crossmember. Save the large washer on the driver side mount. Do not disconnect any power steering lines from Rack and Pinion assembly. Remove the two brackets supporting the power steering lines on the frame, this will allow for slack in the lines while working. **DO NOT ALLOW RACK AND PINNION ASSEMBLY TO HANG.**
12. Remove the factory lower control arms. Save hardware.
13. Disconnect the front drive shaft from the differential. Save hardware. **Do not allow drive shaft to hang freely.**

14. Disconnect all electrical, vacuum lines, and breather lines from the differential. You will need to unbolt the breather line bracket from the top of the differential. Remove the rear differential bracket and save bracket and hardware as you will reuse it during assembly. Remove the two front brackets from the differential. Discard the front brackets as you will not reuse them. Remove the differential from the truck and set aside. **USE CARE WHEN REMOVING DIFFERENTIAL AS TO NOT DAMAGE THE 4WD VACUUM ACTUATOR ASSEMBLY.**
15. Locate the factory rear crossmember. Mark and cut the crossmember as shown 1 1/2" from the cam pocket inward, take care not to cut into the control arm pocket itself. You will use a Sawzall or Die Grinder with a cutoff wheel to make these cuts. Remove the rear crossmember section. Cut and discard. SEE PHOTOS BELOW.



Measure 1 1/2" inward from the cam pocket
For cutting on both sides

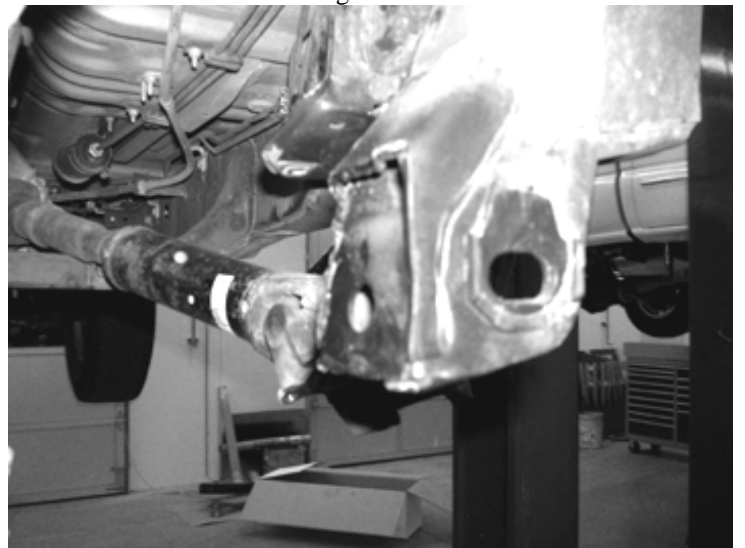

Do not to cut into the control arm pocket.
Driver side shown

16. Locate the factory driver side rear lower control arm pocket. You will need to use a die grinder with a cut off wheel to clearance the frame to allow room for the power steering lines. You will need to measure 2" up into the pocket and cut diagonally from the inside part of the pocket down and outward. Clean all rough and sharp edges so no damage is done to the power steering line. SEE PHOTO BELOW.

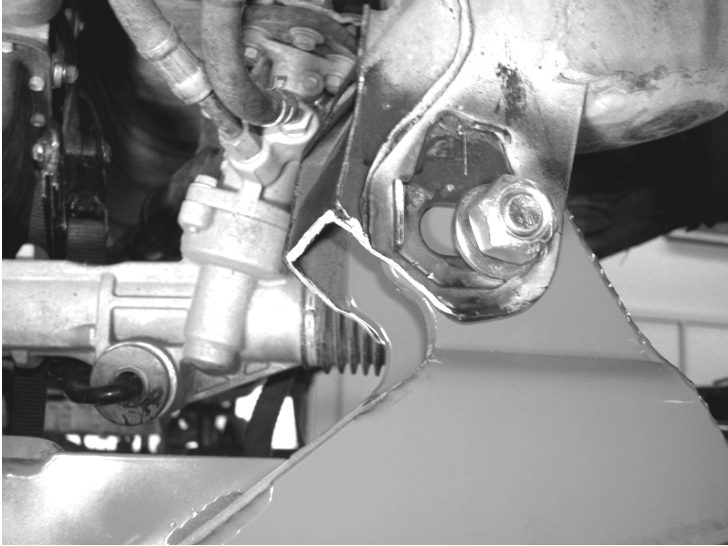

Photo With Crossmember Installed

17. Locate the Fabtech rear crossmember FT70003, with the supplied $\frac{3}{4}$ " x 4 $\frac{1}{2}$ " bolts, nuts, and washers install onto truck. Leave loose

STEP 18 IS FOR V6 MODELS ONLY

18. Locate the pressure line on the Rack and Pinion assembly you will need to loosen the pressure line fitting and rotate it counter clockwise to the 2 o'clock position, retighten.

STEPS 19 & 20 ARE FOR 4CYL MODEL ONLY

19. Locate the pressure line on the Rack and Pinion assembly you will need to remove the pressure line at the rack assembly. Using the FT70037 power steering line extension, connect the extension line first to the factory hose than to the rack assembly. Tighten fittings.
20. Locate the factory power steering return line. Remove the factory line and install the FT70038 lengthened return line using the supplied hose claps.

Continue Installation On All Models

21. Locate the new Fabtech steering shaft coupler FT70010. Install on to the factory steering shaft using stock clinch bolt leave clinch bolt loose. Install the Rack and Pinion assembly onto backside of the Fabtech crossmember. Using the supplied $\frac{1}{2}$ " x 2 $\frac{3}{4}$ " bolt, nut, and washers on the center mount of the rack and pinion assembly, leave loose. You will reuse the factory large washer on the driver side mount along with the supplied $\frac{5}{8}$ "x5" bolt, nut, washer, and the supplied FT70020 spacer (sleeve). On the passenger side mount use the supplied $\frac{1}{2}$ "x5" bolts, nuts, and washers along with the Fabtech spacer block FT70019 (aluminum block). (Note: on

the passenger side mount C-style clamp, make sure the longer sleeve is on the bottom). Attach the steering coupler to the rack and pinion assembly using the supplied $\frac{5}{16}$ " x 2" bolts, nuts, and washers. **Note: check clearance between the new steering shaft and frame, if contact is made you will need to clearance the frame.** SEE PHOTO BELOW.

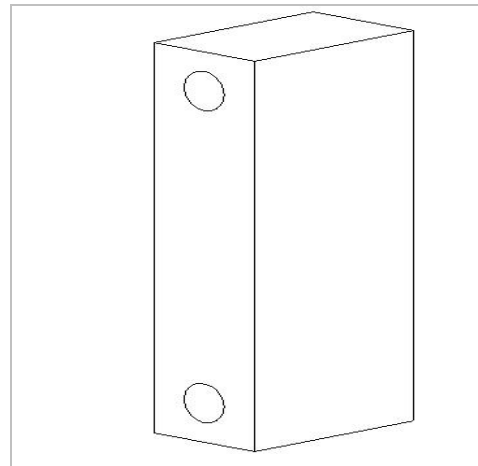
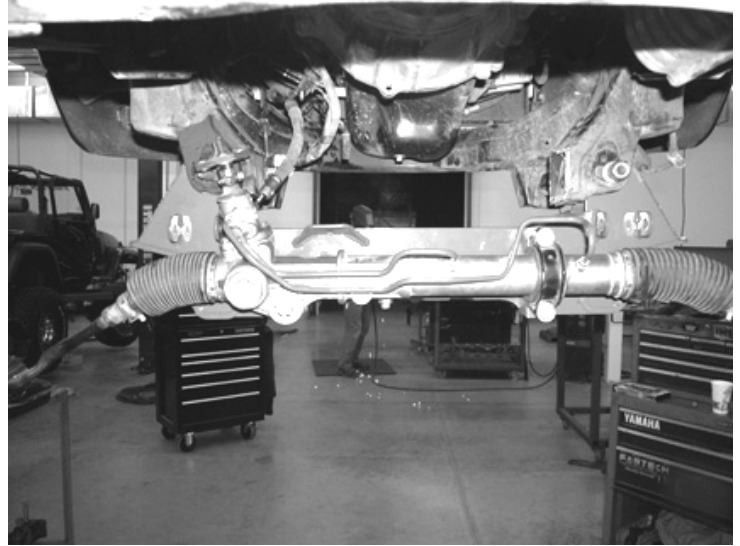

FT70019 Aluminum Spacer

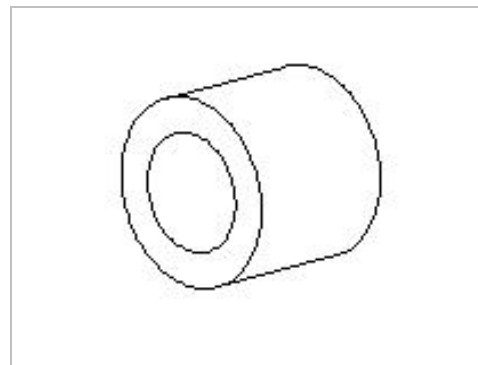

FT70020 Sleeve

22. Using the supplied plastic hose shield, wrap the power steering pressure and return line where they connect to the rack and pinion assembly. SEE PHOTO ON NEXT PAGE.

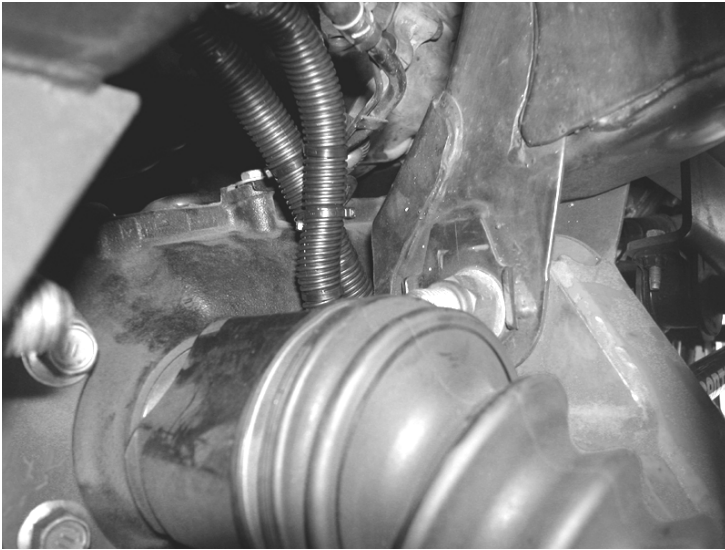

Picture shown with diff. installed & power steering Lines wrapped.

23. With the front differential out of the truck install the two Fabtech front differential brackets using stock hardware, torque to 70 ft lbs. Install the 4 half differential bushing and 2 sleeves provided in the FT90086 bushing kit into the differential brackets. SEE PHOTO BELOW.

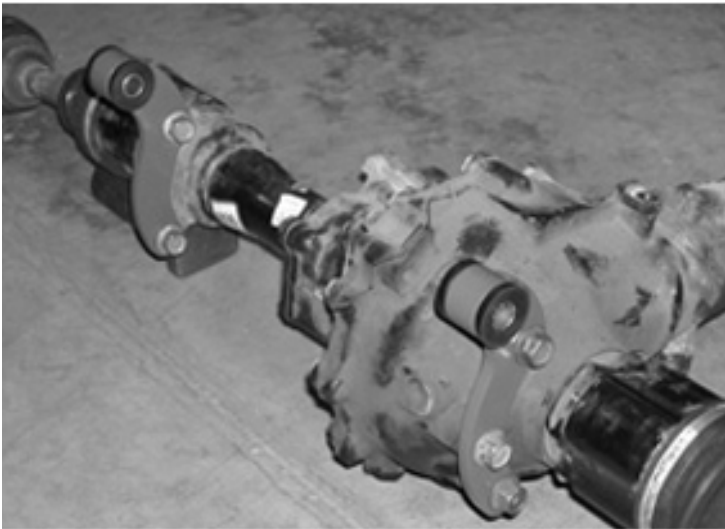

24. Install the differential back into the truck. Support the differential with a transmission jack. Install the rear mount at this time using the stock hardware.
25. Locate the Fabtech front crossmember FT70002 (v6 models) or FT70036 (4cyl. Models), with the supplied 3/4"x4 1/2" bolts, nuts, and washers attach the crossmember to the factory control arm pockets, leave loose. Locate the two holes in the crossmember facing upward, with the supplied 1/2"x5 1/2" bolts, nuts, and washers, attach the crossmember to the frame, leave loose. Connect the front differential brackets to the Fabtech crossmember with the supplied 9/16"x 3" bolts, nuts, washers. Reconnect all electrical, vacuum, and breather lines back to differential.

26. Install the factory lower control arms, using stock alignment bolts and hardware, leave loose.

27. Torque factory control arm pocket bolts to 96 ft lbs. Torque all front differential bolts to 80 ft lbs. Torque the two 1/2" bolts facing upward on the front crossmember to 70 ft lbs.
28. Working from the driver side of the truck, locate the factory shock assembly removed earlier, using a coil spring compressor, compress the factory coil spring and remove it from the factory shock assembly. Install the factory coil spring and factory upper coil hat and isolator on the new Fabtech shock FT70001, using the supplied shock hardware. SEE PHOTOS BELOW.

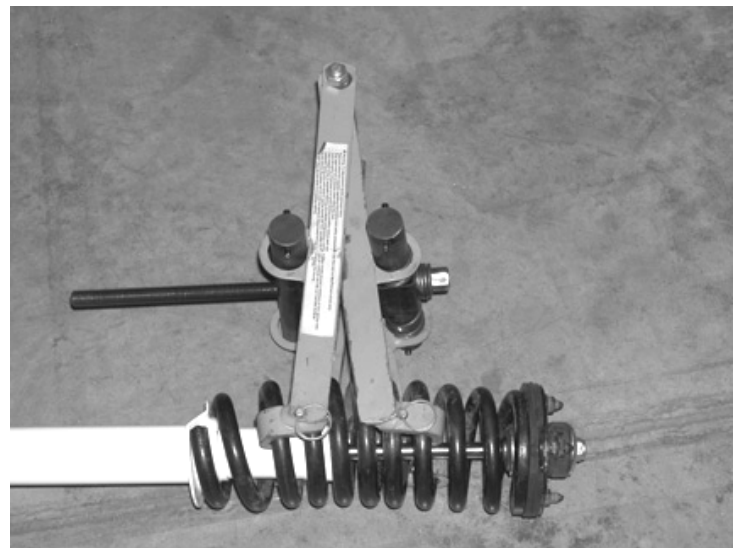

29. Install the new shock assembly into the truck using all the stock hardware. Torque the three upper bolts to 47 ft-lbs and lower bolt to 101 ft-lbs. Torque the lower control arm bolts to 105 ft lbs. SEE PHOTO ON NEXT PAGE.

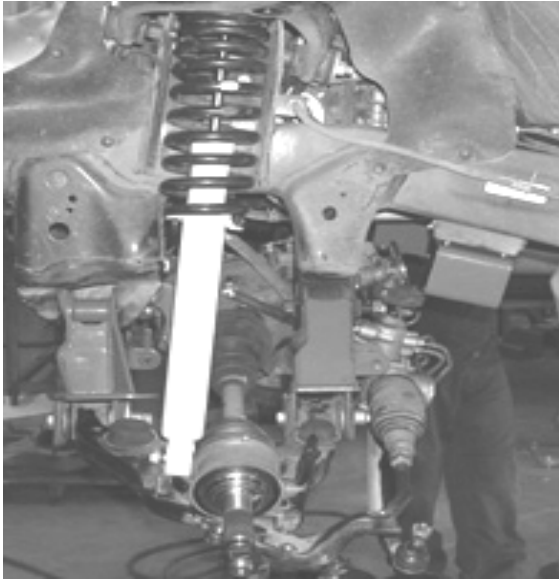

Follow step 30 for Auto Disconnect Hubs or step 31 for Manual Hubs.

Auto Disconnect Hubs (A.D.D.)

30. Locate the factory steering knuckle previously removed. Using a hydraulic press, press out the factory hub from the stock spindle. You will only need to press out the Hub and the ABS ring (if equipped with ABS). You will also need to carefully remove the factory inner bearing seal from the spindle to reuse during install. **NOTE, The drawing on the last page shows the complete assembly, you will not need to press the ball joint in or the bearing and snap ring, this is already done for you.** Next you will need to place the factory dust shield onto the new spindle (do not attach at this time) followed by the supplied FT70027 outer bearing seal, then place the supplied FT70045 thrust washer onto the factory hub. Now CAREFULLY press the hub in the bearing, making sure the bearing is supported properly on the backside while pressing it in. Then CAREFULLY press the stock ABS ring (if equipped) and rear collar back onto the rear side of the hub (when pressing the ABS and collar assembly back on you will now need to support the front of the hub so it is not pressed back out during the procedure. Finally reinstall the factory inner seal. Attach the factory dust shield to the spindle using the factory hardware. SEE DRAWING ON LAST PAGE. **A HYDRAULIC PRESS WILL NEED TO BE USED FOR THIS STEP. USE EXTREME CARE WHEN PRESSING THE HUB ASSEMBLY TOGETHER, INCORRECT ASSEMBLY OR DAMAGE TO BEARINGS DURING ASSEMBLY WILL CAUSE BEARING FAILURE.**

Manual Hubs

31. Locate the factory steering knuckle previously removed. Locate the factory lock nut on the backside of the hub. **Using Toyota Tool Part # SST 09318-12010U** remove the factory lock nut and discard. Using a hydraulic press, press out the factory hub from the stock spindle. You will only need to press out the Hub and the ABS ring if equipped with ABS, the bearing will not be removed. You will also need to carefully remove the factory inner bearing seal from the spindle to reuse during install. **NOTE, The drawing on the last page shows the complete assembly, you will not need to press the ball joint in or the bearing and snap ring, this is already done for you.** Next you will need to place the factory dust shield onto the new spindle (do not attach at this time) followed by the supplied FT70027 outer bearing seal, then place the supplied FT70045 thrust washer onto the factory hub. Now CAREFULLY press the hub in the bearing, making sure the bearing is supported on the backside while pressing it in. Then CAREFULLY place the ABS ring (if equipped) along with the new supplied FT70030 Lock Nut onto the backside of the hub assembly. Torque hub lock nut to 274 ft lbs. Finally reinstall the factory inner seal. Attach the factory dust shield to the spindle using the factory hardware. SEE DRAWING ON LAST PAGE. **A HYDRAULIC PRESS WILL NEED TO BE USED FOR THIS STEP. USE EXTREME CARE WHEN PRESSING THE HUB ASSEMBLY TOGETHER. INCORRECT ASSEMBLY DURING ASSEMBLY WILL CAUSE BEARING FAILURE.**
32. Install the Fabtech knuckle assembly on to truck. Attach the four factory lower ball joint bolts with provided lock tight to steering knuckle first (Torque to 43 ft-lbs), then slide axle shaft through bearing assembly installing axle nut at the same time (torque axle nut to 174 ft lbs), and then attach upper ball joint to the upper control arm using the supplied castle nut and cotter pin (Torque to 105 ft-lbs). Attach the tie rod end, (Torque the tie rod end to 53 ft-lbs) SEE PHOTO BELOW.



33. Locate the factory brake line tab next to upper control arm. Using a die grinder with a cut off wheel cut the tab from the frame. Remove the tab from the brake line at the same time. You will need to carefully pull the hard brake line 4" lower onto the frame. If the truck is equipped with ABS, you will need to route the ABS line to the rear of the upper shock mount. Locate the supplied FT70022 brake line & ABS line bracket, using the supplied 5/16" self tapping screw attach to the frame 1" above the factory bump stop. Using the supplied Adel Clamps and 1/4" bolts, nuts, and washers attach the brake line to forward hole of the bracket and the ABS line to the rear hole on the bracket. SEE PHOTOS BELOW.

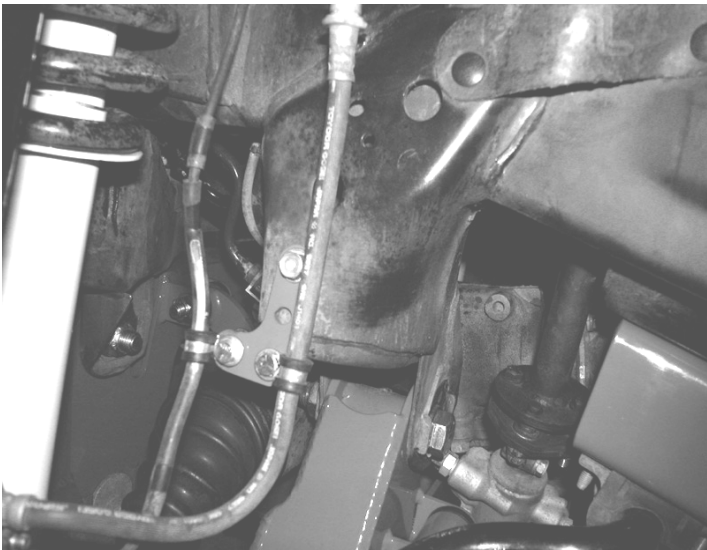
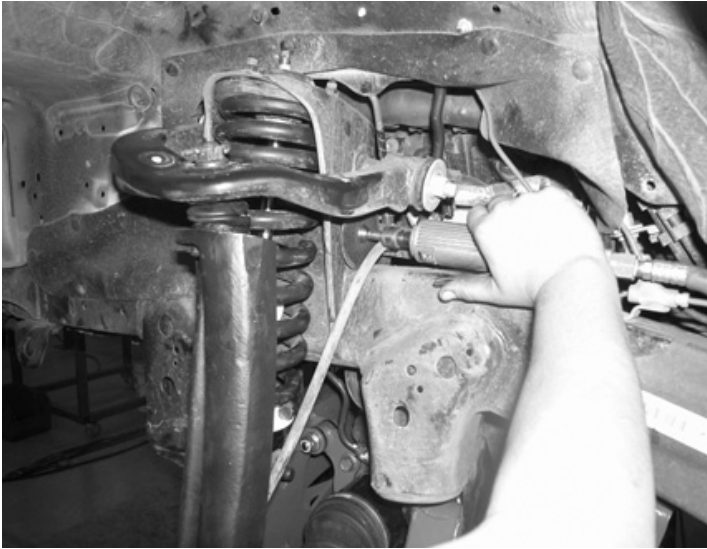

34. Install brake rotor, brake caliper, and bearing dust cover. Route the brake line and ABS line onto back side of the steering knuckle attaching brake line and ABS line to the tab on the rear on steering knuckle using factory hardware. SEE PHOTO IN NEXT COLUMN.

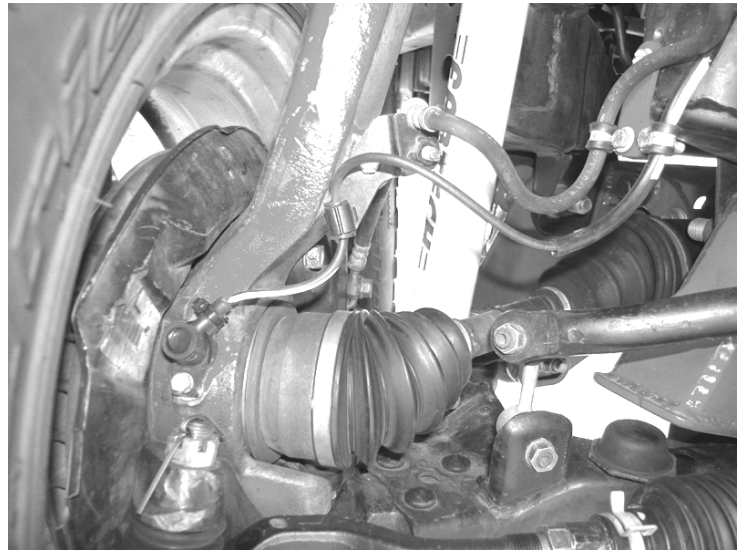

35. If the truck is equipped with ABS, reinstall the factory ABS sensor into the Fabtech Knuckle. If the truck is not equipped with ABS, locate FT70024 ABS Cap. Using the supplied 6mm bolt and split washer attach cap to spindle. SEE PHOTO BELOW.



36. Repeat steps 25 through 33 on the passenger side of truck.
37. Locate the power steering line bracket on the factory front crossmember. Remove and flip the bracket upside down and reattach to the frame using the original hardware. SEE PHOTO ON NEXT PAGE.

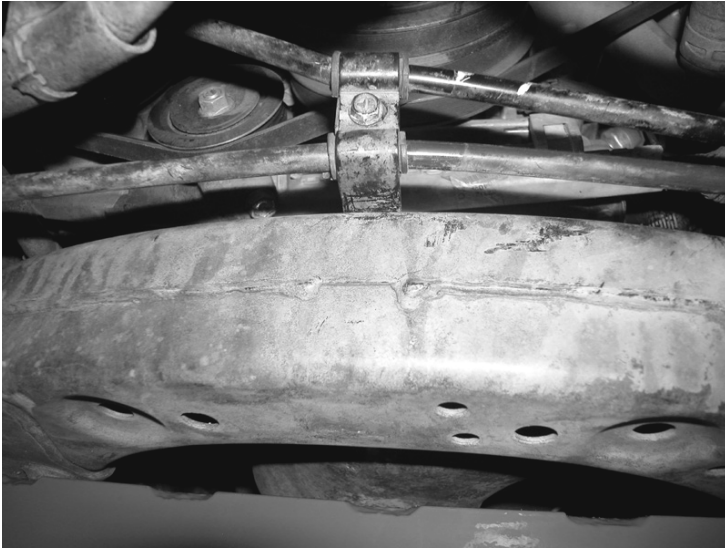

38. Locate the power steering line bracket above the driver side lower control arm. Remove the factory bracket from the frame then from both the pressure line and return line. Using a drill, drill the factory bracket mounting hole out to 1/2". Reattach the bracket to the power steering lines and attach the bracket to the 1/2" bolt on the front crossmember using the supplied 1/2" nut and washer. SEE PHOTO BELOW.



39. Locate the two Fabtech sway bar drop brackets FT70008. Place the side of the bracket with the four holes against the frame, and use the forward two holes. Attach brackets to the frame with supplied 5/16"x 1 1/4" bolts, nuts, washers. Locate the factory sway bar and attach to drop brackets with the factory hardware. Torque all sway bar mount bolts to 19 ft lbs. Attach the end links to lower control arms using factory hardware Torque to 19 ft lbs. SEE PHOTO IN NEXT COLUMN.

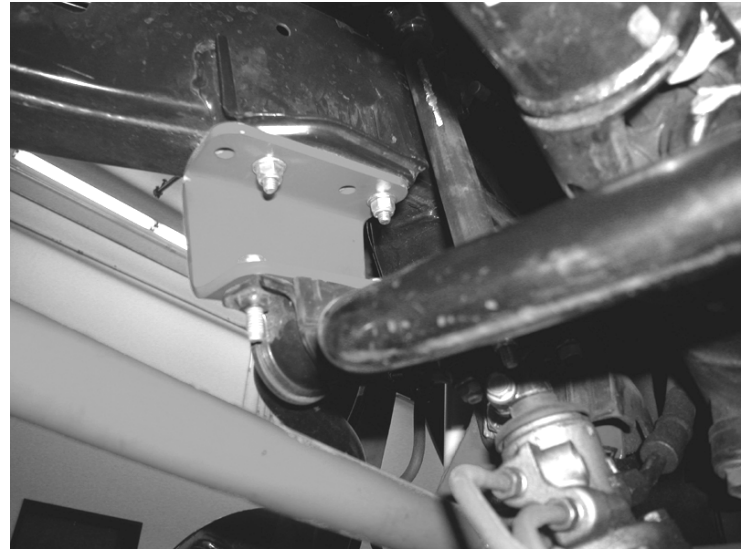

40. Locate and install the differential skid plate FT70006 around the differential housing using supplied (front mount) 1/2"x3 1/2" bolt, (rear mount) 1/2"x 1 1/2" bolt, nut, and washer. SEE PHOTO BELOW.



41. Locate the Impact Strut mounts FT70012. Using a transmission jack support the transmission crossmember. Remove the four factory bolts holding the crossmember in place. Install the impact strut mounts to the factory crossmember with the supplied 3/8"x 5" bolt, nuts, and washers into the factory holes. Locate the hole in the center on the impact strut bracket. Using a drill, carefully drill up completely through the transmission crossmember, Install the 3/8"x 3" bolts, nuts, and washers. Torque Impact mount bolts to 30 ft lbs. SEE PHOTO ON NEXT PAGE.



42. Locate the Fabtech impact strut tubes FT70011. Install the supplied FT1044 bushings into the impact strut tubes. Attach the impact tube to the rear crossmember first and then to the new bracket on the transmission crossmember using the supplied 3/8" x 3" bolts, nuts, and washer. Torque to 30 ft lbs. SEE PHOTO BELOW.



43. Reinstall the wheels and tires and torque to the wheel manufactures specs. Turn wheels left to right to check for proper clearance between brake lines / ABS Lines to tires and wheels with vehicle hanging and on the ground. Reroute lines as required for clearance.

Rear Suspension Instructions: **1995.5-2002**

For 2003 models see next page.

44. Jack up the rear end of the vehicle and support the frame rails with jack stands. Supporting the rear differential remove and discard the rear shocks, save hardware.
45. Locate and disconnect the Emergency brake cable from both rear hub assemblies, save factory hardware as you will reuse it.

46. Locate and remove the brake proportioning rod mount on axle. Locate Fabtech relocating bracket FTS70016 and mount to the axle with the factory hardware. Using the supplied 5/16" x 1 1/4" bolts, nuts, and washers attach the brake proportioning rod mount to the relocating bracket. Torque to 15 ft lbs. SEE PHOTO BELOW.



47. Locate and remove the factory center brake line tab. Locate the Fabtech relocating bracket FTS70015 and attach to the axle with factory hardware. Attach factory brake line tab with supplied 5/16" x 1" bolt, nut, and washers to the Fabtech relocation bracket. Torque to 15 ft lbs. SEE PHOTO BELOW.

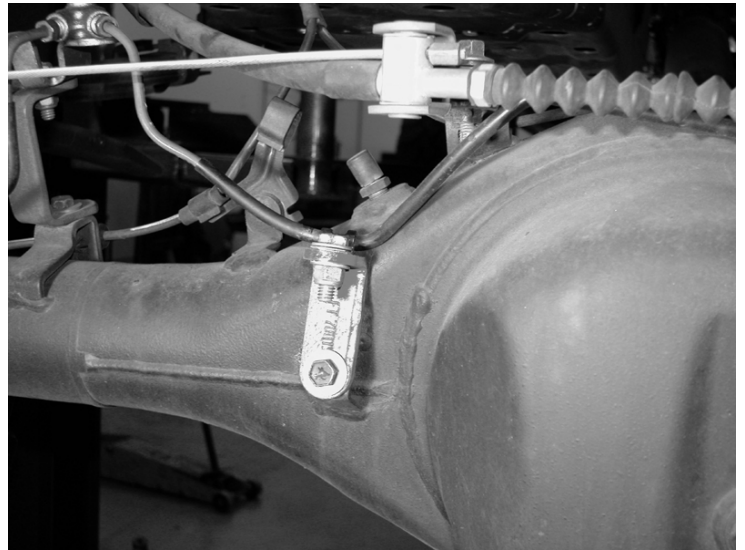

48. Locate the Emergency brake cable and bracket on the driver side rear of the fuel tank. Remove the rear fuel tank bracket bolt and move emergency brake cable outside of bracket. Flip emergency brake cable bracket upside down and reattach with factory hardware. Reattach fuel tank bracket. SEE PHOTOS ON NEXT PAGE.

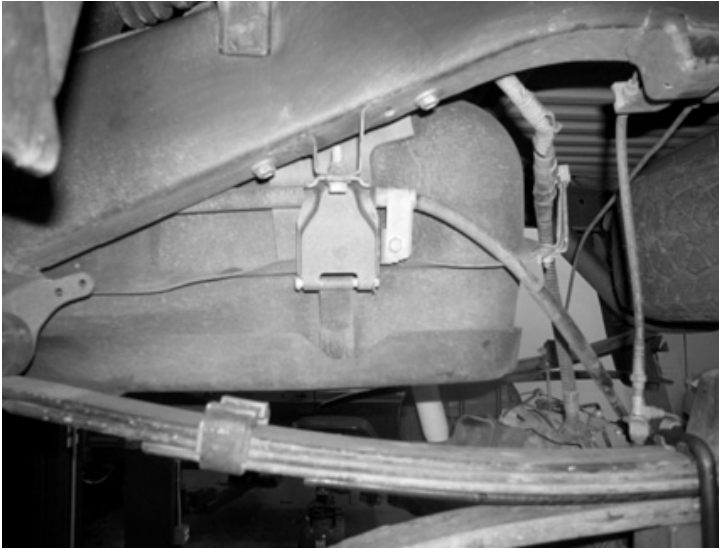

Before

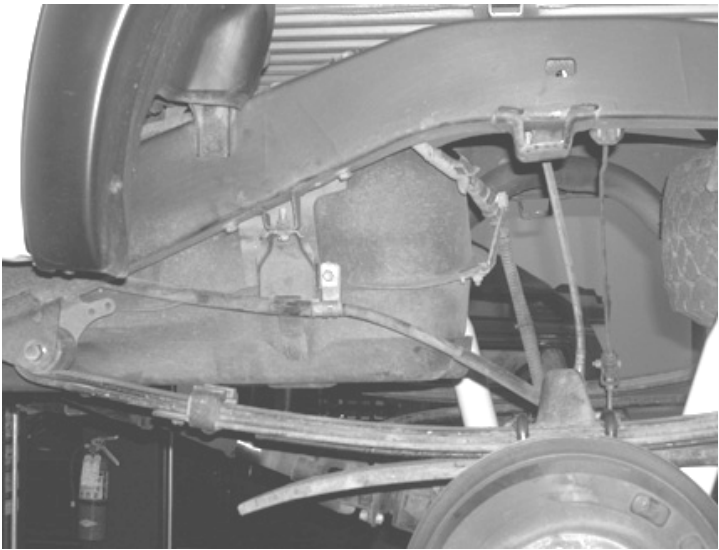

After

49. Locate the emergency brake cable bracket on the driver side of axle attached to the brake line T-fitting, disconnect from the axle and save hardware. Using a die grinder with a cut off wheel you will need cut this bracket off the emergency brake cable, use care not to cut the cable itself, discard bracket. Reconnect emergency brake cable to factory bracket with supplied Adel Clamp and 1/4" x 1" bolt nut, and washer. Locate the Fabtech C-bracket FTS70014 and attach it to the axle with factory hardware. Attach brake line T-fitting to the new Fabtech C-bracket with the supplied 5/16"x 1 1/4" bolt, nut, and washer. Torque to 15 ft lbs. SEE PHOTOS IN NEXT COLUMN.



50. Supporting the rear differential remove and discard the factory u- bolts and blocks. Lower the axle down slowly. Use care not to over extend the brake hose.

51. Clamp the leaf spring in the middle of the spring and remove the center bolt. SEE PHOTO BELOW.

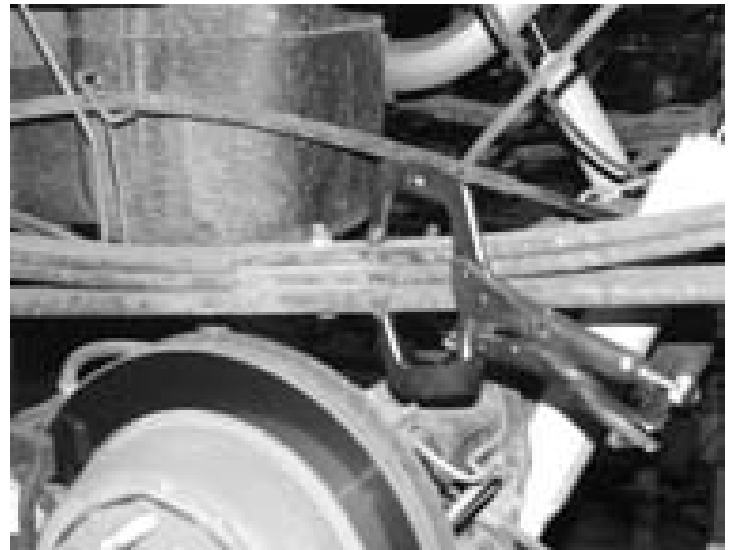

52. Separate the springs and install the provided add a leaf with the new center bolt, the spring pack should form a pyramid pattern, from smallest on the bottom to the longest on top. The factory flat overload leaf will remain on the bottom of the pack. Clamp the spring and tighten the center bolt as not to leave a gap between the springs. Cut the thread of the bolt smooth with the nut. The nut should be on the top of the leaf spring pack.
53. Locate and install the rear lift blocks with the provided short center pin on the bottom of the block, to the axle. The short end of the block should face to the front of the vehicle. Using the provided U bolts, nuts, and washers align axle, lift blocks, stock bump stop, and springs and torque to U Bolts to 90lbs. SEE PHOTO BELOW.



54. Locate the emergency brake cables and hardware previously disconnected from the hubs. Attach the emergency brake cable back to existing bracket on hubs, now locating below the leaf spring pack. SEE PHOTO BELOW.



55. Install the new Fabtech shocks FTS7267 (not include with the kit) with the factory hardware and torque upper and lower bolts to 53lbs.

56. Recheck all bolts for proper torque. Recheck brake hoses and lines for proper clearances.
57. Check the fluid in the front differential. Fill if needed with factory specification differential oil to factory capacity.
58. Install tires and wheels and torque lug nuts to wheel manufacturer's specifications. Turn front tires left to right and check for appropriate tire clearance. Note- Some vehicles may require trimming of the front plastic bumper valance for tire clearance.
59. Check front end alignment and set to factory specifications.

Rear Suspension Instructions: **2003**

60. Jack up the rear end of the vehicle and support the frame rails with jack stands. Supporting the rear differential remove and discard the rear shocks, save hardware.
61. Locate and remove the brake proportioning rod mount on axle. Locate Fabtech relocating bracket FTS70016 and mount to the axle with the factory hardware. Using the supplied 5/16" x 1 1/4" bolts, nuts, and washers attach the brake proportioning rod mount to the relocating bracket. Torque to 15 ft lbs. SEE PHOTO BELOW.



62. Locate and remove the factory center brake line tab. Locate the Fabtech relocating bracket FTS70015 and attach to the axle with factory hardware. Attach factory brake line tab with supplied 5/16" x 1" bolt, nut, and washers to the Fabtech relocation bracket. Torque to 15 ft lbs. SEE PHOTO ON NEXT PAGE.

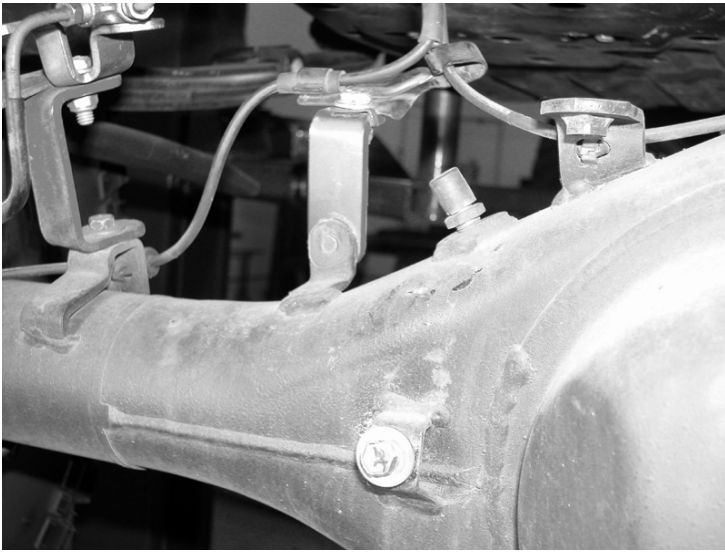

63. Locate the Emergency brake cable and bracket on the driver side rear of the fuel tank. Remove the rear fuel tank bracket bolt and move emergency brake cable outside of bracket. Flip emergency brake cable bracket upside down and reattach with factory hardware. Reattach fuel tank bracket. SEE PHOTOS BELOW.



Before



After

64. Supporting the rear differential remove and discard the factory u- bolts and blocks. Lower axle down slowly. Use care not to over extend the brake hose.
65. Clamp the leaf spring in the middle of the spring and remove the center bolt. SEE PHOTO BELOW.



66. Locate the brake line bracket on the driver side of the rear axle. Disconnect from the axle and save hardware. Locate the supplied FT70032 brake line bracket, attach to the axle using the factory hardware, and attach the brake line tab to the other end using the supplied 1/4" bolt, nut, and washer. SEE PHOTO BELOW.



67. Separate the springs and install the provided add a leaf with the new center bolt, the spring pack should form a pyramid pattern, from smallest on the bottom to the longest on top. The factory flat overload leaf will remain on the bottom of the pack. Clamp the spring and tighten the center bolt as not to leave a gap between the springs. Cut the thread of the bolt smooth with the nut. The nut should be on the top of the leaf spring pack.

68. Locate and install the rear lift blocks with the provided short center pin on the bottom of the block, to the axle. The short end of the block should face to the front of the vehicle. Using the provided U bolts, nuts and washers align axle, lift blocks, stock bump stop, and springs and torque to U Bolts to 90lbs. SEE PHOTO BELOW.



69. Install the new Fabtech shocks FTS7267 (not include with the kit) with the factory hardware and torque upper and lower bolts to 53lbs.
70. Recheck all bolts for proper torque. Recheck brake hoses and lines for proper clearances.
71. Install tires and wheels and torque lug nuts to wheel manufacturer's specifications. Turn front tires left to right and check for appropriate tire clearance. Note- Some vehicles may require trimming of the front plastic bumper valance for tire clearance.
72. Check front-end alignment and set to factory specifications. Re-adjust headlights.

RETORQUE ALL NUTS, BOLTS AND LUGS AFTER 50 MILES AND PERIODICALLY THEREAFTER

For technical assistance call: 909-597-7800

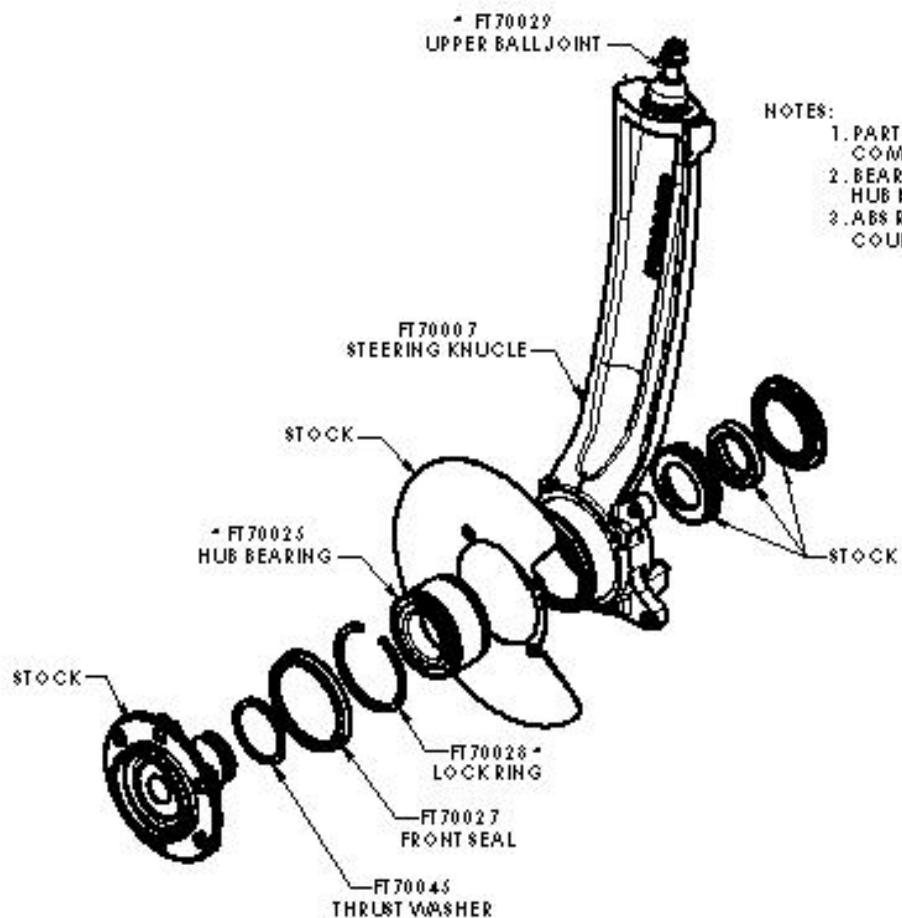

NOTES:

1. PART NUMBERS FT70025, FT70028, & FT70029 COME INSTALLED IN STEERING KNUCLE.
2. BEARING INNER RACE MUST BE SUPPORTED WHEN HUB IS PRESSED INTO THE KNUCKLE ASSEMBLY.
3. ABS RING IS TO BE INSTALLED WITH THE COUNTERBORE FACING AWAY FROM BEARING.

AUTO DISCONNECT HUBS WITH ABS

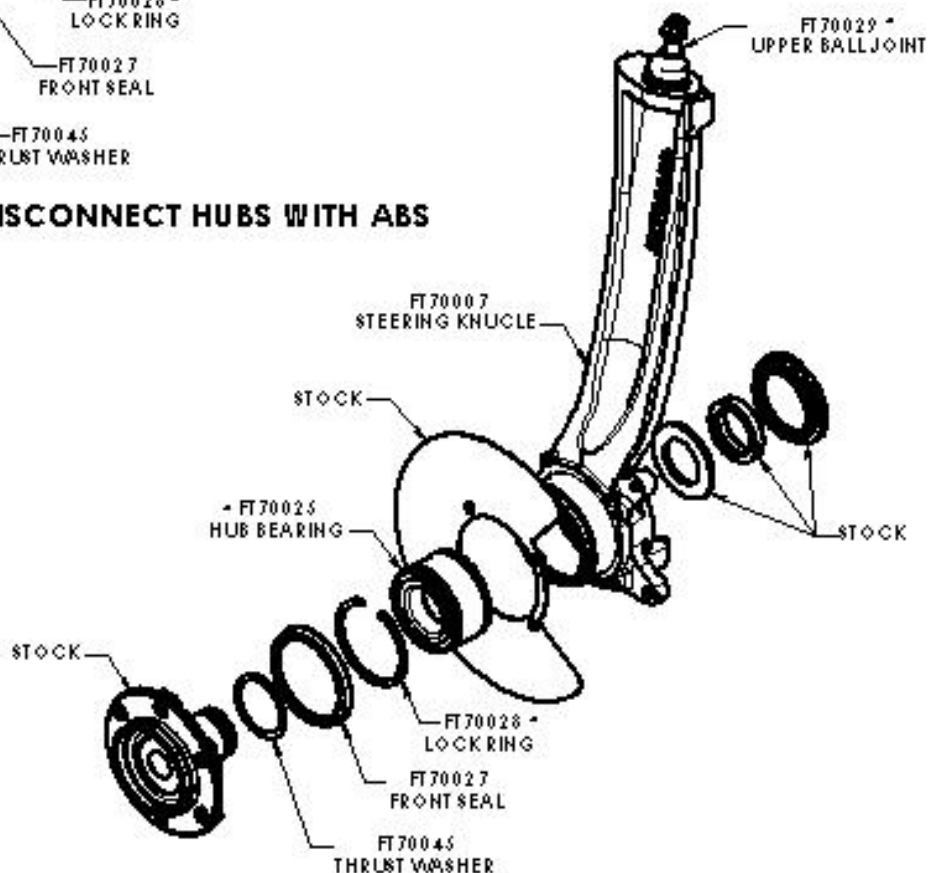

AUTO DISCONNECT HUBS WITHOUT ABS

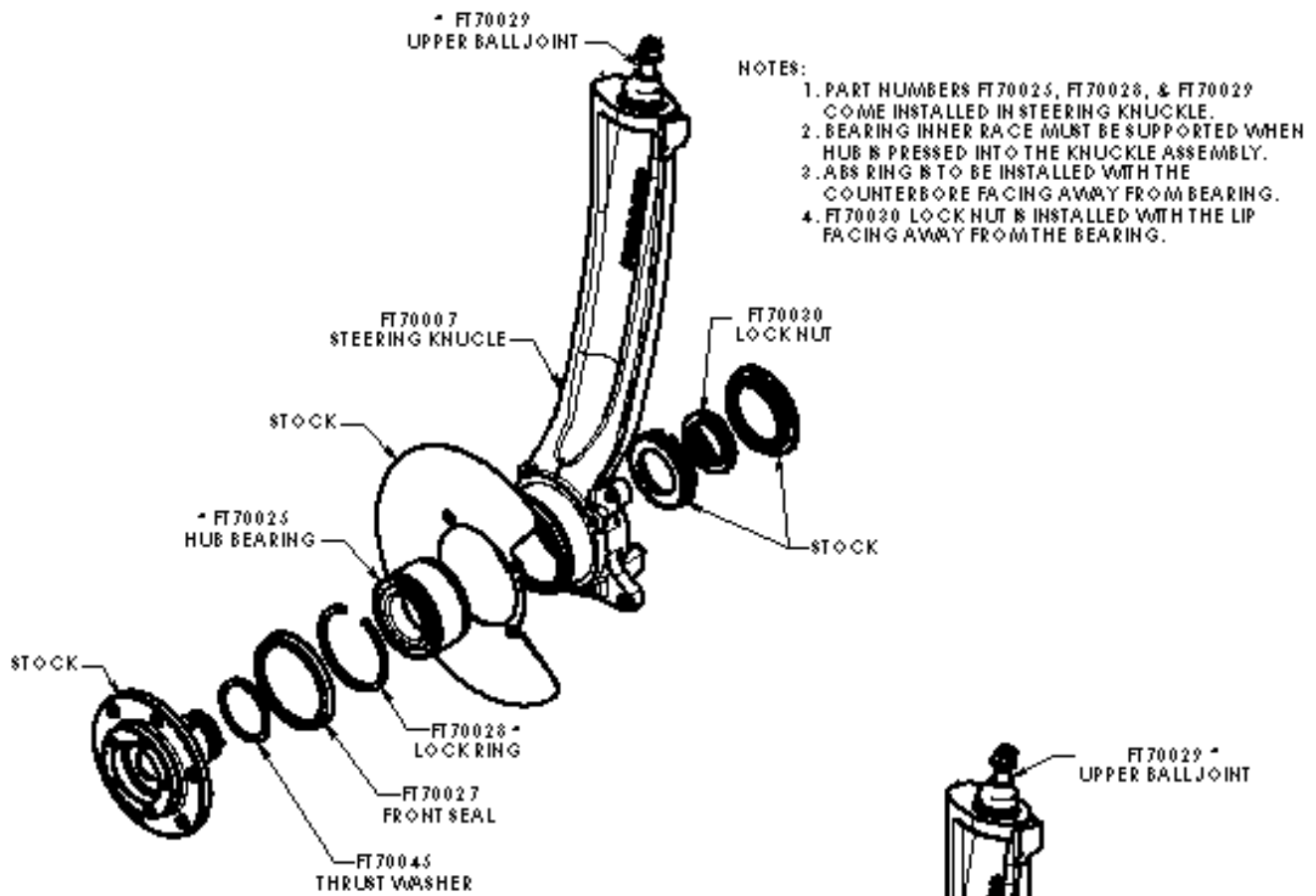

MANUAL HUBS WITH ABS

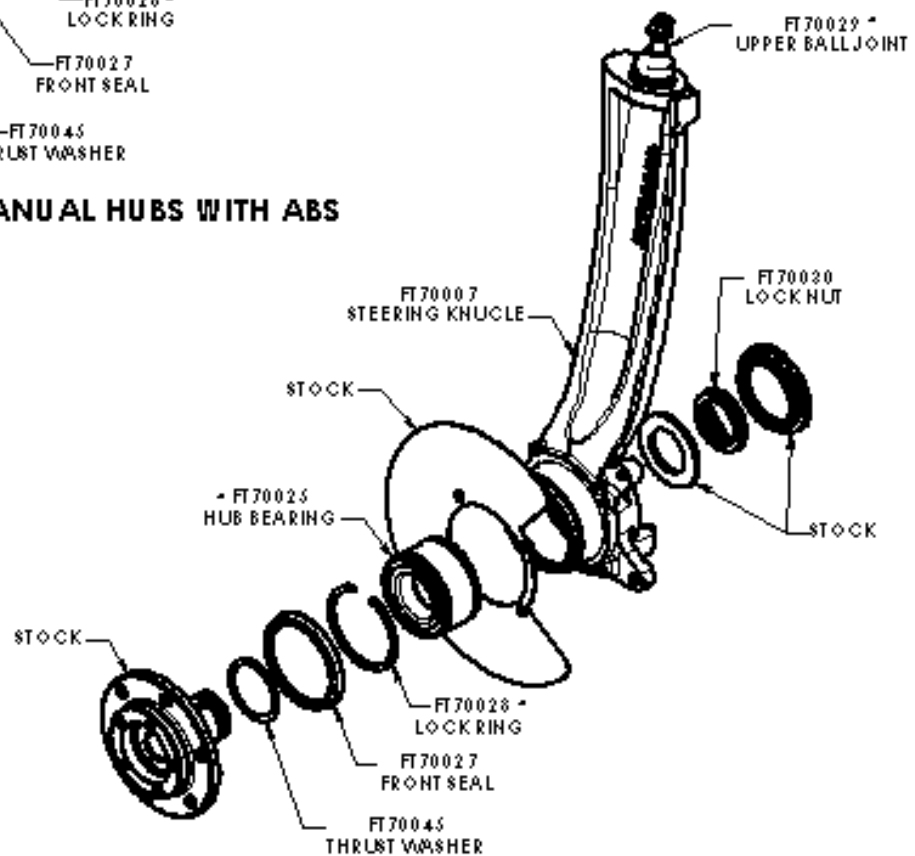

MANUAL HUBS WITHOUT ABS

RETORQUE ALL NUTS, BOLTS AND LUGS AFTER 50 MILES AND PERIODICALLY THEREAFTER

For technical assistance call: 909-597-7800

Product Warranty and Warnings-

Fabtech provides a Limited Lifetime Warranty to the original retail purchaser who owns the vehicle, on which the product was originally installed, for defects in workmanship and materials.

The Limited Lifetime Warranty excludes the following Fabtech items; bushings, bump stops, ball joints, tie rod ends, limiting straps, cross shafts, heim joints. These parts are subject to wear and are not considered defective when worn. They are warranted for 60 days from the date of purchase for defects in workmanship.

Take apart shocks are considered a serviceable shock with a one year warranty on leakage only. Service seal kits are available separately for future maintenance. All other shocks are covered under our Limited Lifetime Warranty.

Fabtech does not warrant any product for finish, alterations, modifications and/or installation contrary to Fabtech's instructions. Alterations to the finish of the parts including but not limited to painting, powdercoating, plating and/or welding will void all warranties. Some finish damage may occur to parts during shipping which is considered normal and is not covered under warranty.

Fabtech products are not designed nor intended to be installed on vehicles used in race applications or for racing purposes or for similar activities. (A "RACE" is defined as any contest between two or more vehicles, or any contest of one or more vehicle against the clock, whether or not such contest is for a prize). This warranty does not include coverage for police or taxi vehicles, race vehicles, or vehicles used for government or commercial purposes. Also excluded from this warranty are sales outside of the United States of America.

Installation of most suspension products will raise the center of gravity of the vehicle and will cause the vehicle to handle differently than stock. It may increase the vehicle's susceptibility to a rollover, on road and off road, at all speeds. Extreme care should be taken to operate the vehicle safely at all times to prevent rollover or loss of control resulting in serious injury or death. Fabtech front end Desert Guards may impair the deployment or operation of vehicles equipped with supplemental restraining systems/air bag systems and should not be installed if the vehicle is equipped as so.

Fabtech makes every effort to ensure suspension product compatibility with all vehicles listed in the catalog, but due to unknown auto manufacturer's production changes and/or inconsistencies by the auto manufacturer, Fabtech cannot be responsible for 100% compatibility, including the fitment of tire and wheel sizes listed. The Tire and Wheel sizes listed in Fabtech's catalog are only a guideline for street driving with noted fender trimming. Fabtech is not responsible for damages to the vehicle's body or tires.

Fabtech's obligation under this warranty is limited to the repair or replacement, at Fabtech option, of the defective product only. All costs of removal, installation or re-installation, freight charges, incidental or consequential damages are expressly excluded from this warranty. Fabtech is not responsible for damages and/or warranty of other vehicle parts related or non related to the installed Fabtech product. This warranty is expressly in lieu of all other warranties expressed or implied. This warranty shall not apply to any product that has been subject to accident, negligence, alteration, abuse or misuse as determined by Fabtech.

Fabtech suspension components must be installed as a complete system including shocks as shown in our current catalog. All warranties will become void if Fabtech parts are combined and/or substituted with other aftermarket suspension products. Combination and/or substitution of other aftermarket suspension parts may cause premature wear and/or product failure resulting in an accident causing injury or death. Fabtech does not warrant products not manufactured by Fabtech.

Installation of Fabtech product may void the vehicles factory warranty; it is the consumer's responsibility to check with their local vehicle's dealer for warranty disposition before the installation of the product.

It is the responsibility of the distributor and/or the retailer to review all warranties and warnings of Fabtech products with the consumer prior to purchase.

Fabtech reserves the right to supercede, discontinue, change the design, finish, part number and, or application of parts when deemed necessary without written notice. Fabtech is not responsible for misprints or typographical errors within the catalog or price sheet.